

Solid State Relay G3NE

Compact, Low-cost, SSR Switching
5 to 20 A

- Wide load voltage range: 75 to 264 VAC.
- Dedicated, compact aluminum PCB and power elements used.
- Built-in varistor effectively absorbs external surges.
- Quick-connect #110 input terminals and #250 output connections. (#187 input terminals available).
- Approved by UL, CSA and TÜV; marked with CE.



Ordering Information

To order: Select the part number and add the desired coil voltage rating, (e.g., G3NE-205T-US DC24)

Isolation	Zero cross function	Indicator	Rated output load (applicable output load)	Rated input voltage	Model
Phototriac	Yes	No	5 A at 100 to 240 VAC (5 A at 75 to 264 VAC)	5, 12, 24 VDC	G3NE-205T-US
			10 A at 100 to 240 VAC (10 A at 75 to 264 VAC)		G3NE-210T-US
			20 A at 100 to 240 VAC (20 A at 75 to 264 VAC)		G3NE-220T-US
	No		5 A at 100 to 240 VAC (5 A at 75 to 264 VAC)		G3NE-205TL-US
			10 A at 100 to 240 VAC (10 A at 75 to 264 VAC)		G3NE-210TL-US
			20 A at 100 to 240 VAC (20 A at 75 to 264 VAC)		G3NE-220TL-US

Note: For information on ordering #187 input terminals contact your local Omron representative

ACCESSORIES (ORDER SEPARATELY)

Heat Sink

The following heat sinks are thin and can be track-mounted.
See *Dimensions* for details.

Part number	Applicable SSR
Y92B-N50	G3NE-205T(L)/-210T(L)
Y92B-N100	G3NE-220T(L)

Specifications

■ RATINGS

Input

Rated voltage	Operating voltage	Voltage level		Input impedance	
		Must operate	Must release	With zero cross function	Without zero cross function
5 VDC	4 to 6 VDC	4 VDC max.	1 VDC min.	250 Ω ±20%	300 kΩ ±20%
12 VDC	9.6 to 14.4 VDC	9.6 VDC max.		600 Ω ±20%	800 kΩ ±20%
24 VDC	19.2 to 28.8 VDC	19.2 VDC max.		1.6 kΩ ±20%	

Note: Each model has 5-VDC, 12-VDC, and 24-VDC input versions.

Output

Part number	Applicable load				
	Rated load voltage	Load voltage range	Load current		Inrush current
			With heat sink	Without heat sink	
G3NE-205T(L)-US	100 to 240 VAC	75 to 264 VAC	0.1 to 5 A	0.1 to 5 A	60 A (60 Hz, 1 cycle)
G3NE-210T(L)-US			0.1 to 10 A (see note)	0.1 to 5 A	150 A (60 Hz, 1 cycle)
G3NE-220T(L)-US			0.1 to 20 A (see note)	0.1 to 5 A	220 A (60 Hz, 1 cycle)

Note: These values apply when using a dedicated radiator or a radiation plate of specified size.

■ CHARACTERISTICS

Item	G3NE-2□□T-US	G3NE-2□□TL-US
Operate time	1/2 of load power source cycle + 1 ms max.	1 ms max.
Release time	1/2 of load power source cycle + 1 ms max.	
Output ON voltage drop	1.6 V (RMS) max.	
Leakage current	5 mA max. (at 100 VAC) 10 mA max. (at 200 VAC)	
Insulation resistance	100 MΩ min. (at 500 VDC)	
Dielectric strength	2,000 VAC, 50/60 Hz for 1 min	
Vibration resistance	Malfunction: 10 to 55 Hz, 1.5-mm double amplitude	
Shock resistance	Malfunction: 1,000 m/s ² {approx. 100G}	
Ambient temperature	Operating: -30°C to 80°C (with no icing nor condensation) Storage: -30°C to 100°C (with no icing nor condensation)	
Ambient humidity	Operating: 45% to 85%	
Approved standards	UL508 File No.E64562/CSA C22.2 (No.0, No.14) File No. LR35535 TÜV R9051064 (VDE0435) (EN60950)	
Weight	Approx. 37 g	

Engineering Data

Load Current vs. Ambient Temperature Characteristics

G3NE-205T(L)-US

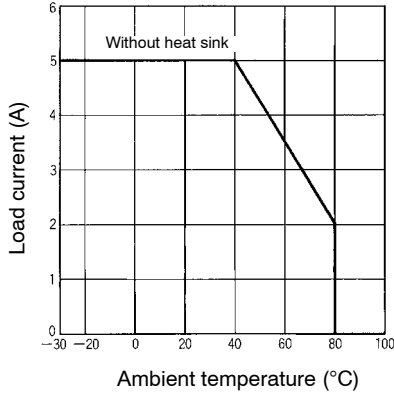

G3NE-210T(L)-US

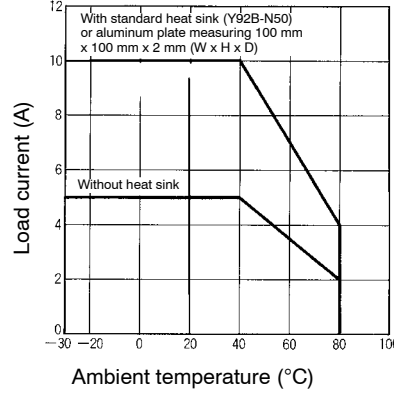

G3NE-220T(L)-US

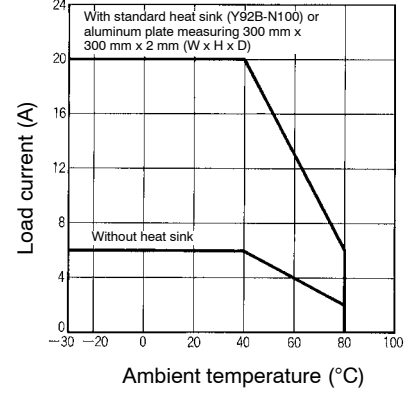

Inrush Current Resistivity

Non-repetitive (Keep the inrush current to half the rated value if it occurs repetitively.)

G3NE-205T(L)-US

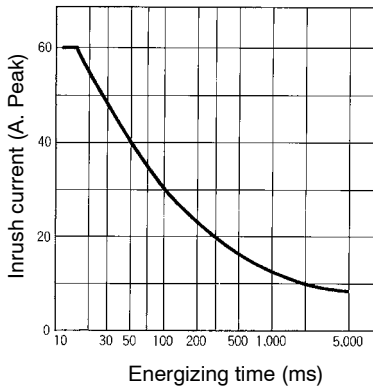

G3NE-210T(L)-US

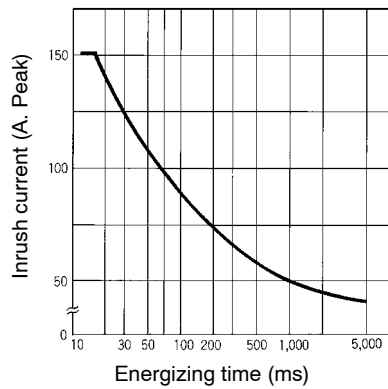

G3NE-220T(L)-US

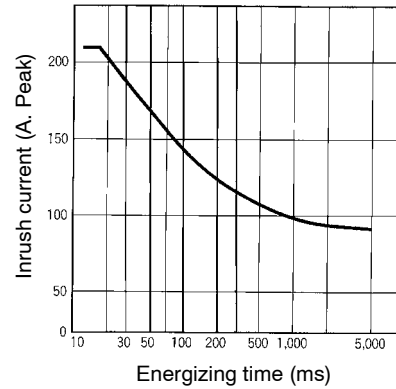

Dimensions

Unit: mm (inch)

G3NE-205T(L)/210T(L)/220T(L)-US

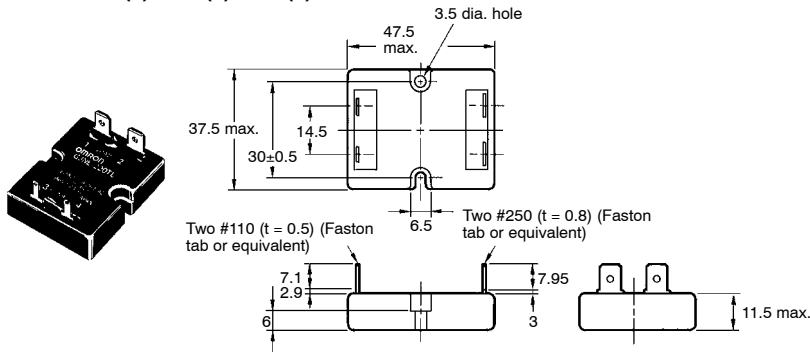

Terminal Arrangement/ Internal Connections (Top View)

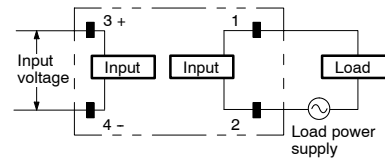

Mounting Holes

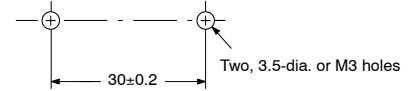

Heat Sink Y92B-N50

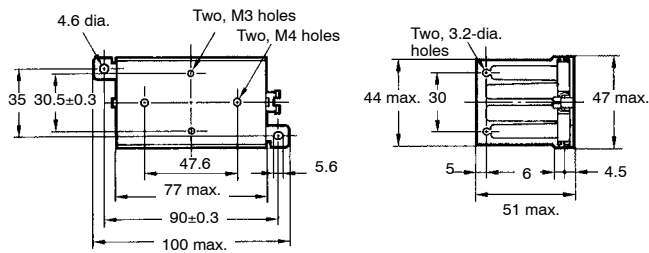
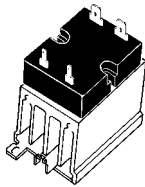

Mounting Holes

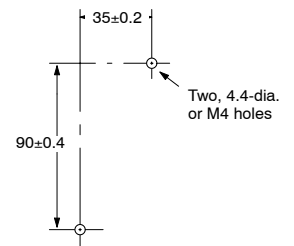

Weight: approx. 200 g

Y92B-N100

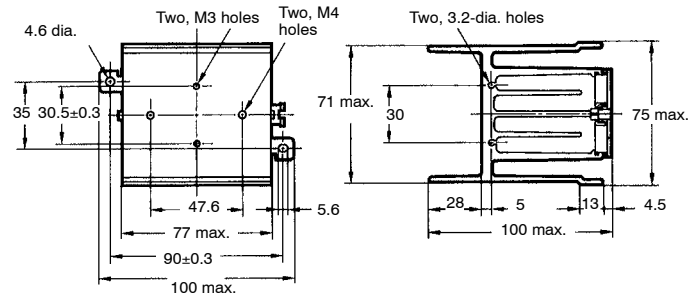
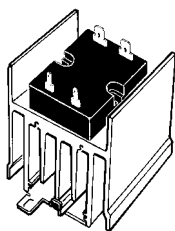

Mounting Holes

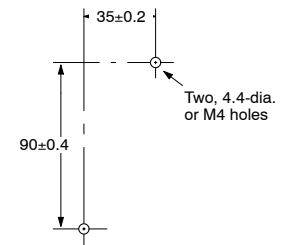

Weight: approx. 400 g

■ APPROVALS

UL (File No. E64562)/CSA File No. LR35535

Input voltage	SSR type	Output ratings
5, 12, 24 VDC	G3NE-205	5 A resistive 240 VAC, 3 A Tungsten 240 VAC, 3.2 A FLA 19.2 A LRA 240 VAC, 50/60 Hz
	G3NE-210	10 A resistive 240 VAC, 7.5 A Tungsten 240 VAC, 4.8 A FLA 28.8 A LRA 240 VAC, 50/60 Hz
	G3NE-210	5 A resistive 240 VAC, 5 A Tungsten 240 VAC, 3 A FLA, 18 A LRA, 240 VAC, 50/60 Hz
	G3NE-220	20 A resistive 240 VAC, 11 A Tungsten 240 VAC, 11.1 FLA, 66.6 LRA, 240 VAC, 50/60 Hz
	G3NE-220	6 A resistive 240 VAC, 6 A Tungsten 240 VAC, 3.3 FLA, 19.8 LRA, 240 VAC, 50/60 Hz

Precautions

Refer to the pages at the back of the catalog for general precautions.

Although the LOAD terminal are internally connected to a snubber circuit that absorbs noises, do not wire power lines or high-tension lines with the load connecting lines of the G3NE in the same conduit or the G3NE may be damaged or malfunction.

Because the operation time of the G3NE is extremely short, take measures to suppress noise induced between the INPUT terminals. If generation of strong noise is expected, connect an external noise absorber such as an RC circuit.

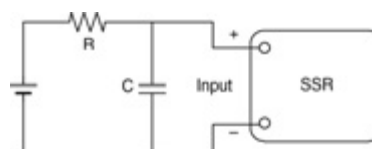

Do not apply excessive force to the terminals. Exercise care when pulling or inserting the terminal clips.

When attaching a heat sink to the G3NE, apply heat conductive grease on the heat sink. Tighten the mounting screws of the heat sink with a torque of 0.59 to 0.98 N-m.

NOTE: DIMENSIONS SHOWN ARE IN MILLIMETERS. To convert millimeters to inches divide by 25.4.

ALL DIMENSIONS SHOWN ARE IN MILLIMETERS. To convert millimeters into inches, divide by 25.4



OMRON ELECTRONICS LLC

One Commerce Drive
Schaumburg, IL 60173

847-882-2288

OMRON CANADA, INC.

885 Milner Avenue
Toronto, Ontario M1B 5V8

416-286-6465

OMRON ON-LINE

Global - <http://www.omron.com>
USA - <http://www.omron.com/oei>
Canada - <http://www.omron.ca>