

I/O SSR Used as Interface between Logic Circuitry and Load

- A variety of AC/DC input and output modules classified by the color.
- Operation can be monitored easily through an LED indicator.
- Dielectric strength of 4,000 V between input and output terminals.
- Approved by UL and CSA.

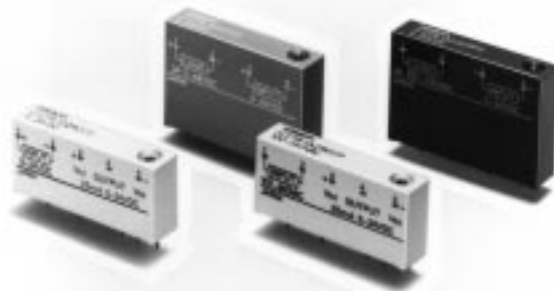

Ordering Information

Input Module

Isolation	Indicator	Logic level		Rated input voltage	Model
		Supply voltage	Supply current		
Photocoupler	Yes	4 to 32 VDC	25 mA	100 to 240 VAC	G3TB-IAZR02P-US
				4 to 32 VDC	G3TB-IDZR02P-US

Output Module

Isolation	Zero cross function	Indicator	Rated output voltage (Applicable output load)	Rated input voltage	Model
Photocoupler	Yes	Yes	3 A at 100 to 240 VAC (3 A at 75 to 264 VAC)	5 to 24 VDC	G3TB-OA203PZ-US
		No		4 to 24 VDC	G3TB-OA203PZM-US
	No	Yes	3 A at 5 to 48 VDC (3 A at 4 to 60 VDC)	5 to 24 VDC	G3TB-OA203PL-US
		No		4 to 24 VDC	G3TB-OA203PLM-US
	---	Yes	3 A at 5 to 48 VDC (3 A at 4 to 60 VDC)	5 to 24 VDC	G3TB-ODX03P-US
				4 to 24 VDC	G3TB-ODX03PM-US
		No	1.5 A at 48 to 200 VDC (1.5 A at 40 to 200 VDC)	5 to 24 VDC	G3TB-OD201P-US
				4 to 24 VDC	G3TB-OD201PM-US

Specifications

■ Ratings

Input Module

Input

Model	Rated voltage	Operating voltage	Input current	Voltage level	
				Must operate voltage	Must release voltage
G3TB-IAZR02P-US	100 to 240 VAC	80 to 264 VDC	5 mA max.	80 VAC max.	10 VAC min.
G3TB-IDZR02P-US	4 to 24 VDC	3 to 32 VDC		3 VDC max.	1 VDC min.

Output

Model	Logic level supply voltage	Output breakdown voltage	Output current
G3TB-IAZR02P-US	4 to 32 VDC	32 VDC max.	25 mA max.
G3TB-IDZR02P-US			

Output Module

Input

Model	Rated voltage	Operating voltage	Input current	Voltage level	
				Must operate voltage	Must release voltage
G3TB-OA203PZ-US	5 to 24 VDC	4 to 32 VDC	5 mA max.	4 VDC max.	1 VDC min.
G3TB-OA203PZM-US	4 to 24 VDC	3 to 32 VDC		3 VDC max.	
G3TB-OA203PL-US	5 to 24 VDC	4 to 32 VDC		4 VDC max.	
G3TB-OA203PLM-US	4 to 24 VDC	3 to 32 VDC		3 VDC max.	
G3TB-ODX03P-US	5 to 24 VDC	4 to 32 VDC		4 VDC max.	
G3TB-ODX03PM-US	4 to 24 VDC	3 to 32 VDC		3 VDC max.	
G3TB-OD201P-US	5 to 24 VDC	4 to 32 VDC		4 VDC max.	
G3TB-OD201PM-US	4 to 24 VDC	3 to 32 VDC		3 VDC max.	

Output

Model	Applicable load			
	Rated load voltage	Load voltage range	Load current (see note)	Inrush current
G3TB-OA203PZ-US	100 to 240 VAC	75 to 264 VAC	0.05 to 3 A	45 A (60 Hz, 1 cycle)
G3TB-OA203PZM-US				
G3TB-OA203PL-US				
G3TB-OA203PLM-US				
G3TB-ODX03P-US	5 to 48 VDC	4 to 60 VDC	0.01 to 3 A	18 A (10 ms)
G3TB-ODX03PM-US	48 to 200 VDC	40 to 200 VDC	0.01 to 1.5 A	12 A (10 ms)
G3TB-OD201P-US				
G3TB-OD201PM-US				

Note: The minimum current value is measured at 10°C min.

■ Characteristics

Input Module

Item	G3TB-IAZR02P-US	G3TB-IDZR02P-US
Operate time	20 ms max.	1 ms max.
Release time	20 ms max.	1 ms max.
Output ON voltage drop	0.4 V max.	
Leakage current	100 μA max.	
Insulation resistance	100 MΩ min. (at 500 VDC)	
Dielectric strength	4,000 VAC, 50/60 Hz for 1 min between input and output	
Vibration resistance	Malfunction: 10 to 55 Hz, 1.5-mm double amplitude	
Shock resistance	Malfunction: 1,000 m/s ²	
Ambient temperature	Operating: -30°C to 80°C (with no icing or condensation) Storage: -30°C to 100°C (with no icing or condensation)	
Ambient humidity	Operating: 45% to 85%	
Approved standards	UL508 File No. E41515/CSA C22.2 (No.0, No.14) File No. LR35535/TÜV R90381 (VDE0806)	
Weight	Approx. 22 g	

Output Module

Item	G3TB-OA 203PZ-US	G3TB-OA2 03PZM-US	G3TB-OA 203PL-US	G3TB-OA 203PLM-US	G3TB-OD X03P-US	G3TB-OD X03PM-US	G3TB-OD 201P-US	G3TB-OD 201PM-US
Operate time	1/2 of load power source cycle + 1 ms max.		1 ms max.		0.5 ms max.			
Release time	1/2 of load power source cycle + 1 ms max.				2 ms max.			
Output ON voltage drop	1.6 V max.						2.5 V max.	
Leakage current	5 mA max. (at 200 VAC)				1 mA max.			
Insulation resistance	100 M Ω min. (at 500 VDC)							
Dielectric strength	4,000 VAC, 50/60 Hz for 1 min between input and output							
Vibration resistance	Malfunction: 10 to 55 Hz, 1.5-mm double amplitude							
Shock resistance	Malfunction: 1,000 m/s ²							
Ambient temperature	Operating: -30°C to 80°C (with no icing or condensation) Storage: -30°C to 100°C (with no icing or condensation)							
Ambient humidity	Operating: 45% to 85%							
Approved standards	UL508 File No. E64562/CSA C22.2 (No.0, No.14) File No. LR35535/TÜV R90381 (VDE0806)							
Weight	Approx. 32 g							

Engineering Data

Load Current vs. Ambient Temperature Characteristics

G3TB-OA203PZ-US/-OA203PZM-US
/OA203PL-US/-OA203PLM-US/
G3TB-ODX03P-US/-ODX03PM-US

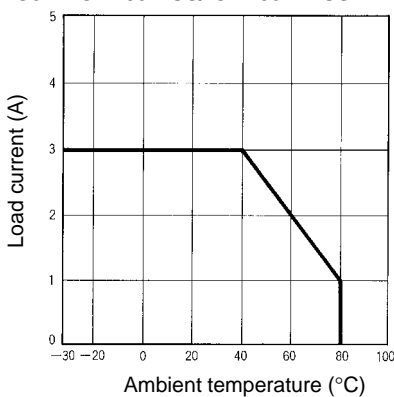

G3TB-OD201P-US/-OD201PM-US

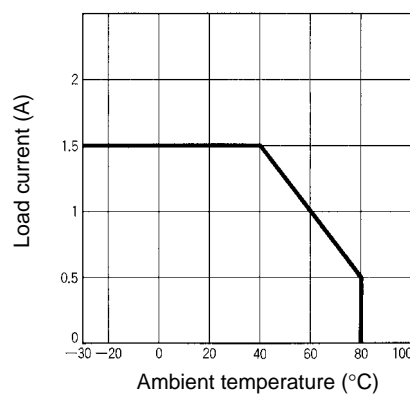

Inrush Current Resistivity

Non-repetitive (Keep the inrush current to half the rated value if it occurs repetitively.)

G3TB-OA203PZ-US/-OA203PZM-US/
-OA203PL-US/-OA203PLM-US

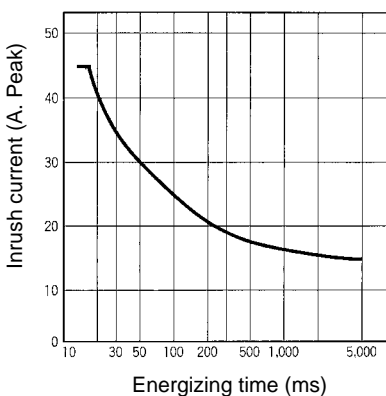

G3TB-ODX03P-US/-ODX03PM-US

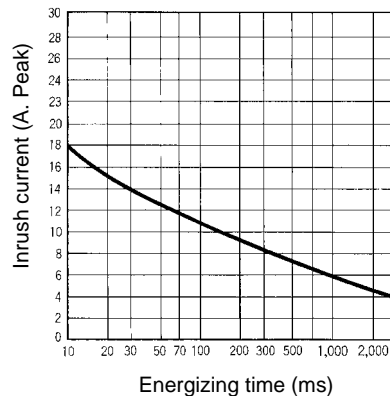

G3OD201P-US/-OD201PM-US

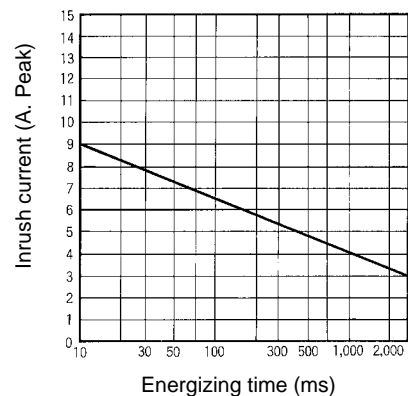

Operation

■ Circuit Configuration

Type	Model	Case color	Indicator	Circuit
AC input	G3TB-IAZR02P-US	Yellow	Yes	Rectification circuit → Constant-current circuit → Amplification circuit
DC input	G3TB-IDZR02P-US	White	Yes	Constant-current circuit → Amplification circuit
AC output	G3TB-OA203PZ-US	Black	Yes	Constant-current circuit → Zero cross circuit → Drive circuit
	G3TB-OA203PL-US		No	
	G3TB-OA203PZM-US G3TB-OA203PLM-US		No	
DC output	G3TB-ODX03P-US	Red	Yes	Constant-current circuit → Amplification circuit
	G3TB-OD201P-US		No	
	G3TB-ODX03PM-US G3TB-OD201PM-US		No	

Example of Logic Output Circuit

Example 1

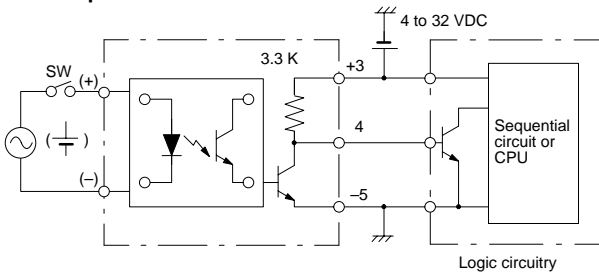

Example 2

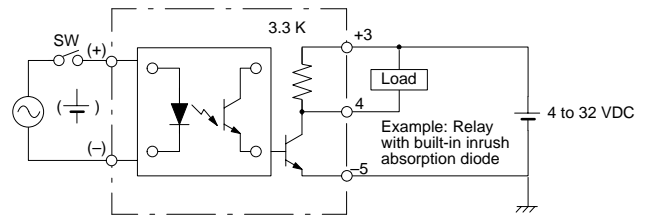

Note: AC- and DC-input versions are available.

Dimensions

Note: All units are in millimeters unless otherwise indicated.

Input SSR

G3TB-I

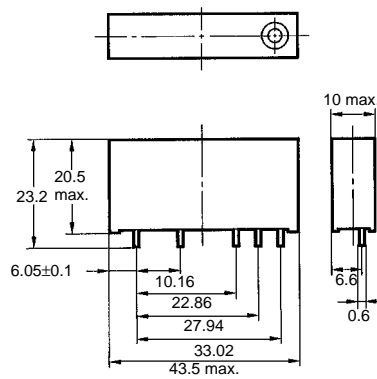
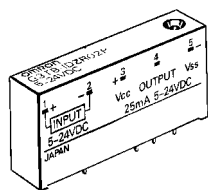

PCB Dimensions (Bottom View)

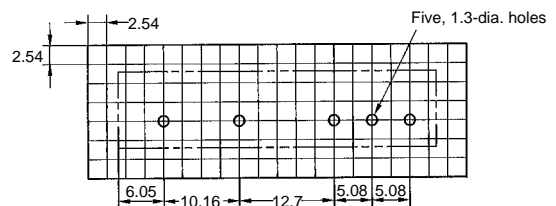

Terminal Arrangement (Bottom View)

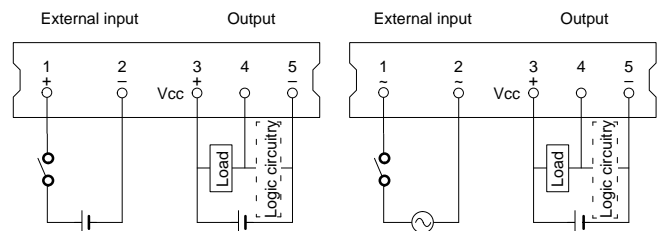

Output SSR

G3TB-O

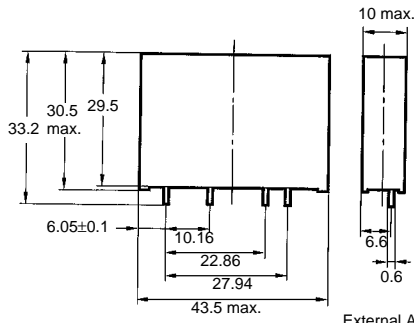
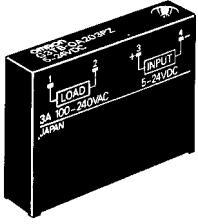

PCB Dimensions
(Bottom View)

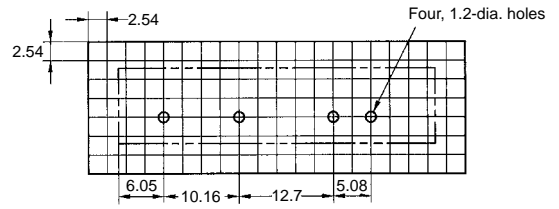

Terminal Arrangement
(Bottom View)

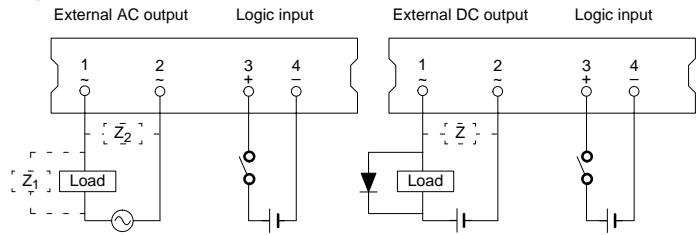

Note: Z₁, Z₂, and Z refer to overvoltage absorption elements that you should connect.

Precautions

Refer to pages 11 to 19 for general precautions.

G3TB

I/O classification by the color is as follows:

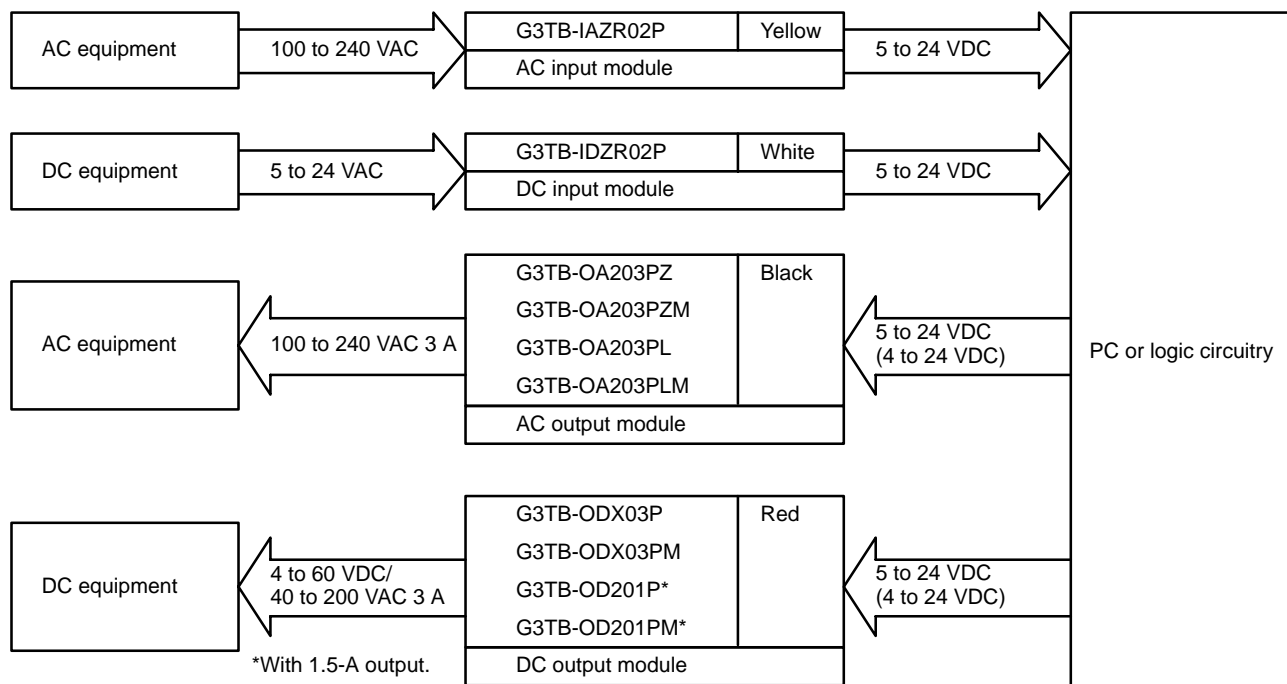

When mounting more than one output module, make a distance of 5 mm minimum between adjacent SSRs. Up to 16-point, 3-A load switching is possible.

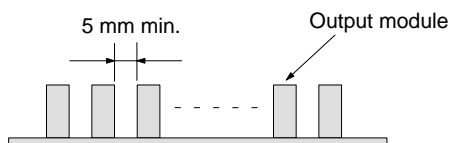

Connection

With the SSR for DC switching, the load can be connected to either positive or negative output terminal of the SSR.

Protective Component

Since the SSR does not incorporate an overvoltage absorption component, be sure to connect an overvoltage absorption component when using the SSR under an inductive load.

ALL DIMENSIONS SHOWN ARE IN MILLIMETERS.

To convert millimeters into inches, multiply by 0.03937. To convert grams into ounces, multiply by 0.03527.