

Low Signal Relay G6K

- Fourth generation design.
- Design based on worldwide communications, computer peripheral and office automation relay requirements.
- Offers excellent board space savings.
- Meets 2.5 kV Bellcore surge requirements.
- Terminal design based on Omron's successful G6S relay.
- Available in PCB through-hole, SMT gullwing and SMT "inside-L" terminals.
- Ambient temperature range of -40 to +85°C.
- Complies with UL1950 Basic Insulation at 125 V.
- Available in 2.54 and 3.2 mm coil-contact terminal spacing versions.
- Available in single coil latching.

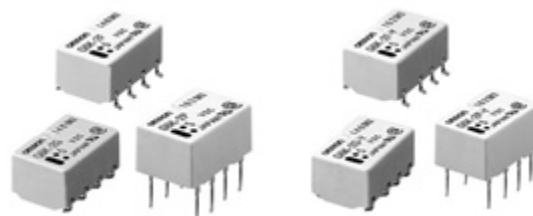

Ordering Information

To Order: Select the part number and add the desired coil voltage rating (e.g., G6K-2F-DC5).

| Terminal | Contact form | Model | | |
|------------------|--------------|---------------------------------|---|---|
| | | Non-latching 2.54 mm spacing | Non-latching 3.2 mm coil-contact terminal spacing | Single coil latching 3.2 mm coil-contact terminal spacing |
| Gullwing | DPDT | G6K-2F | G6K-2F-Y | G6KU-2F-Y |
| Inside "L" | DPDT | G6K-2G | G6K-2G-Y | G6KU-2G-Y |
| PCB through-hole | DPDT | G6K-2P | G6K-2P-Y | G6KU-2P-Y |

Specifications

■ Contact data

| | |
|-------------------------|-------------------------|
| Load | Resistive load (cosφ=1) |
| Rated load | 0.3 A at 125 VAC |
| | 1 A at 30 VDC |
| Contact material | Ag (Au clad) |
| Max. carry current | 1 A |
| Max. operating voltage | 125 VAC, 60 VDC |
| Max. operating current | 1 A |
| Max. switching capacity | 37.5 VA, 30W |
| Min. permissible load | 10 μA at 10 mVDC |

G6K- 2.5 mm coil-contact terminal spacing, standard, non-latching (G6K-2F, G6K-2G, G6K-2P)

G6K- 3.2 mm coil-contact terminal spacing, non-latching (G6K-2F-Y, G6K-2G-Y, G6K-2P-Y)

| Rated voltage (VDC) | Rated current (mA) | Coil resistance (Ω) | Pick-up voltage | Dropout voltage | Maximum voltage | Power consumption (mW) |
|---------------------|--------------------|---------------------|------------------|-----------------|------------------------|------------------------|
| | | | % of rated value | | | |
| 3 | 33.0 | 91 | 80% max. | 10% min. | 150% max. (at 85°C) | 100 (approx.) |
| 4.5 | 23.2 | 194 | | | | |
| 5 | 21.1 | 237 | | | | |
| 6 | 17.6 | 341 | | | | |
| 9 | 11.3 | 795 | | | | |
| 12 | 9.1 | 1,315 | | | | |
| 24 | 4.6 | 5,220 | | | | |

G6KU- 3.2 mm spacing, single coil latching (G6KU-2F-Y, G6KU-2G-Y, G6KU-2P-Y)

| Rated voltage (VDC) | Rated current (mA) | Coil resistance (Ω) | Set-up voltage | Reset voltage | Maximum voltage | Power consumption (mW) |
|---------------------|--------------------|---------------------|------------------|---------------|------------------------|------------------------|
| | | | % of rated value | | | |
| 3 | 33.0 | 91 | 80% max. | 80 % min. | 150% max. (at 85°C) | 100 (approx.) |
| 4.5 | 23.2 | 194 | | | | |
| 5 | 21.1 | 237 | | | | |
| 6 | 17.6 | 341 | | | | |
| 9 | 11.3 | 795 | | | | |
| 12 | 9.1 | 1,315 | | | | |
| 24 | 4.6 | 5,220 | | | | |

- Note:**
1. The rated current and coil resistance are measured at a coil temperature of 23°C (73°F) with a tolerance of ± 10%.
 2. The operating characteristics are measured at a coil temperature of 23°C (73°F) unless otherwise specified.
 3. Pick-up voltage is measured with no carry current across the contacts.
 4. Pick-up voltage will vary with temperature.
 5. Specifications subject to change without notice.

■ Characteristics

| | | |
|-------------------------------------|-------------------------------|--|
| Contact resistance (initial) | | 100 mΩ max. |
| Operate time (set time) | | 3 ms max. |
| Release time (reset time) | | 3 ms max. |
| Bounce time | | 3 ms max. |
| Insulation resistance | | 1,000 MΩ min. (at 500 VDC) |
| Dielectric strength | | 1,500 VAC for 1 minute between coil contacts 1,000 VAC for 1 minute between contacts of different poles 750 VAC for 1 minute between contacts of the same pole |
| Surge withstand voltage | | 2,500 V, 2x10 μs (conforms to Bellcore specifications) between coil and contacts 1,500 V, 10x160 μs (conforms to FCC Part 68) between contacts of different poles 1,500 V, 10x160 μs (conforms to FCC Part 68) between contacts of different poles |
| Vibration | Mechanical durability | 10 to 55 Hz; 5.0 mm double amplitude |
| | Malfunction durability | 10 to 55 Hz; 3.3 mm double amplitude |
| Shock | Mechanical durability | 1,000 m/s ² , approx. 100G |
| | Malfunction durability | 750 m/s ² , approx. 75G |
| Ambient temperature | | -40°C to 85°C (-40°F to 185°F) |
| Humidity | | 35 to 85% RH |
| Service life | Mechanical | 50,000,000 operations min. (at 36,000 operations per hour) |
| | Electrical | 100,000 operations min. at rated load (at 1,800 operations per hour) |

Note: Data shown are of initial value.

Characteristic data

Max. Switching Capacity

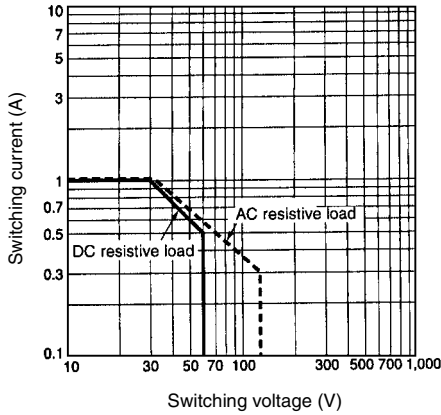

Ambient Temperature vs. Maximum Coil Voltage

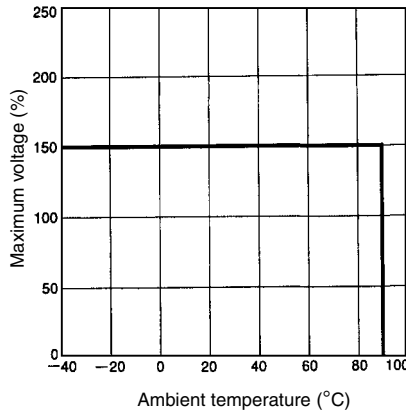

Ambient Temperature vs. Pick-up and Dropout Voltage

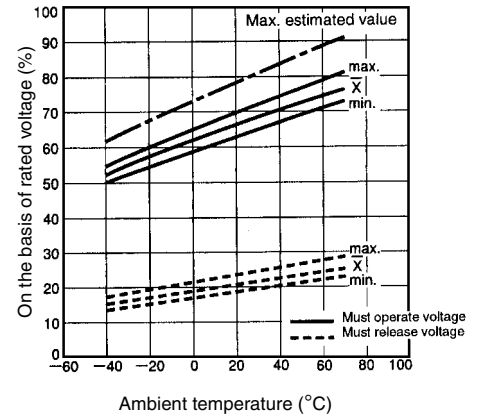

Electrical Service Life

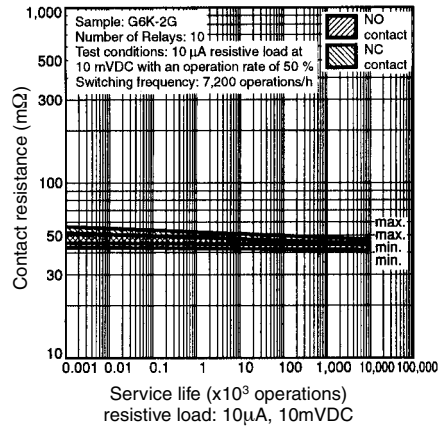
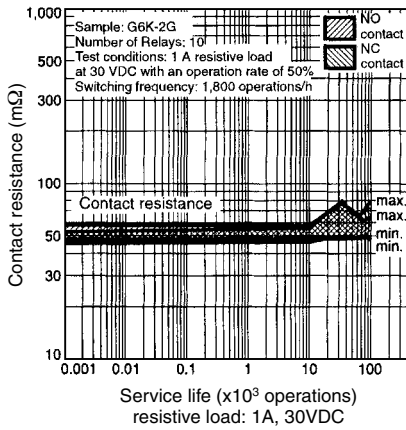
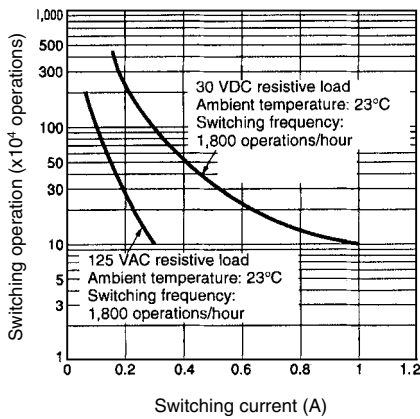

High-frequency Characteristics

Isolation

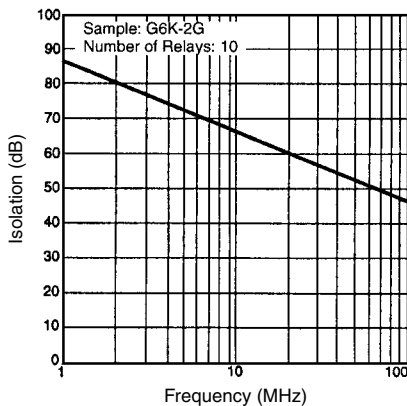

Insertion Loss

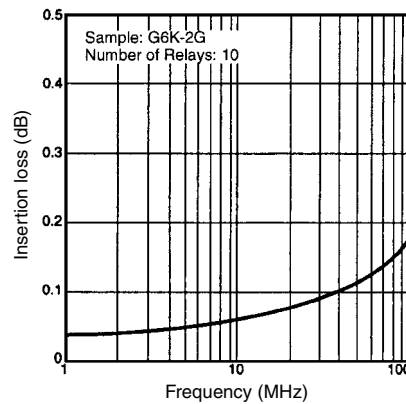

VSWR and Return Loss

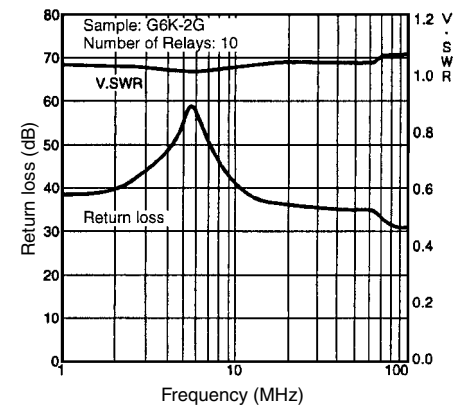

■ Approvals

UL (File No. E41515) / CSA (File No. LR24825)

| Type | Contact form | Coil rating | Contact ratings |
|-----------|--------------|-------------|-----------------|
| G6K-2F | DPDT | 3 to 24 VDC | 0.3 A, 125 VAC |
| G6K-2G | | | 0.5 A, 60 VDC |
| G6K-2P1 | | | 1 A, 30 VDC |
| G6K-2F-Y | | | |
| G6K-2G-Y | | | |
| G6K-2P-Y | | | |
| G6KU-2F-Y | | | |
| G6KU-2G-Y | | | |
| G6KU-2P-Y | | | |

Note: Complies with UL1950 Basic Insulation at 125 V (pollution degree 1 for internal spacings, pollution degree 2 for external spacings).

Dimensions

Unit: mm (inch)

■ Relays

G6K-2F

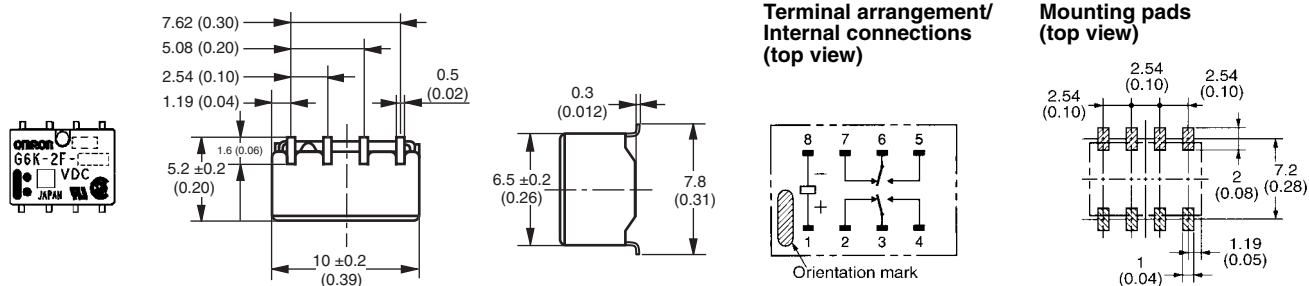

G6K-2G

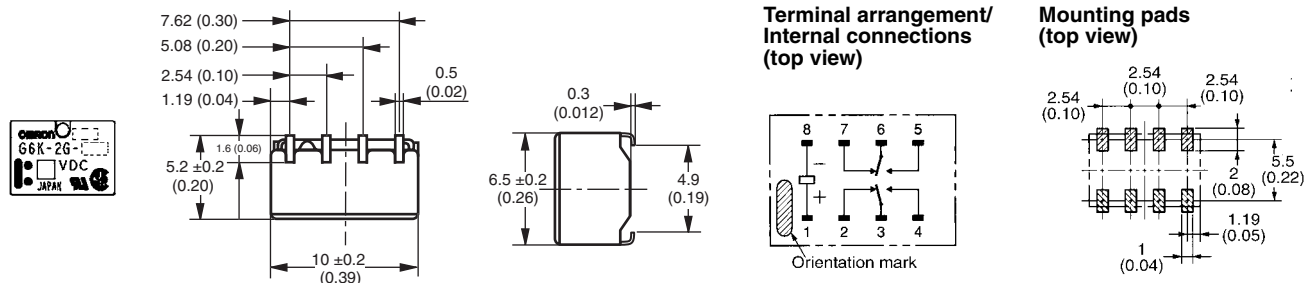

G6K-2P

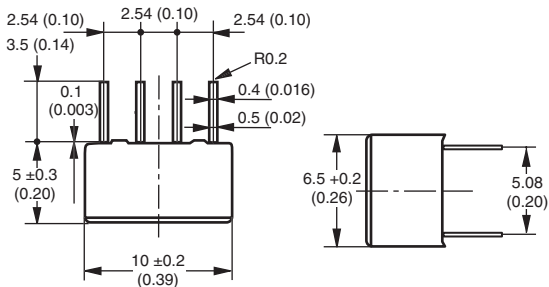
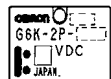

**Terminal arrangement/
Internal connections
(top view)**

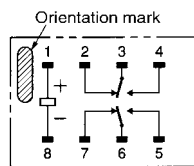

**Mounting pads
(top view)**

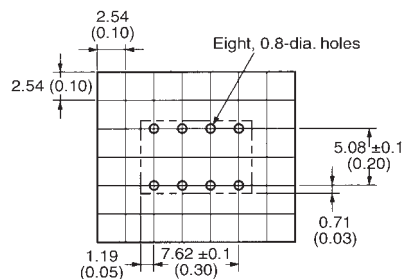

G6K-2F-Y

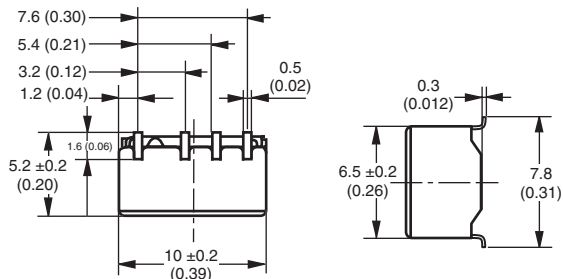
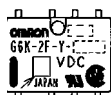

**Terminal arrangement/
Internal connections
(top view)**

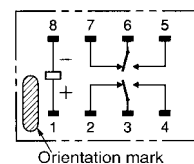

**Mounting pads
(top view)**

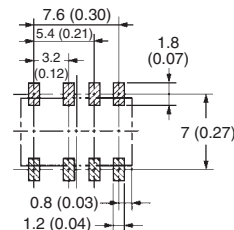

G6K-2G-Y

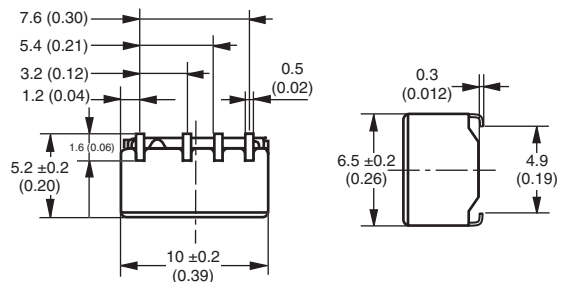

**Terminal arrangement/
Internal connections
(top view)**

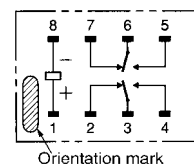

**Mounting pads
(top view)**

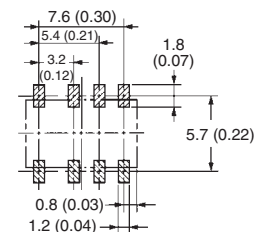

G6K-2P-Y

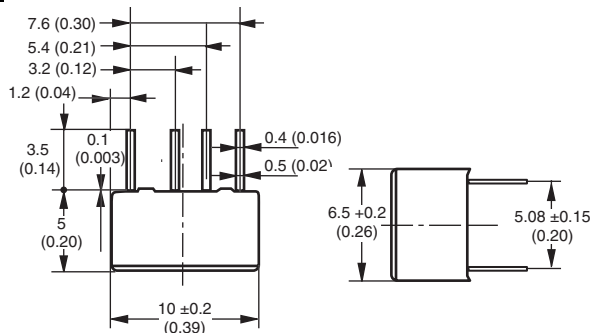
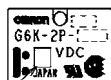

**Terminal arrangement/
Internal connections
(top view)**

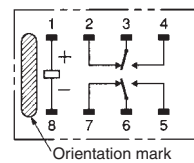

**Mounting pads
(top view)**

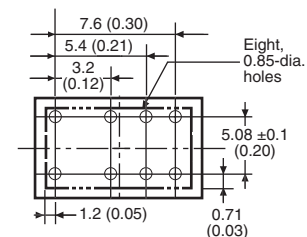

G6KU-2F-Y

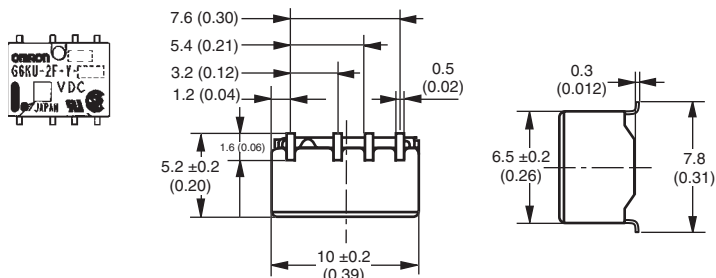

Terminal arrangement/
Internal connections
(top view)

Mounting pads
(top view)

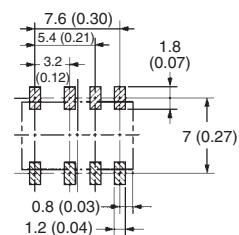

G6KU-2G-Y

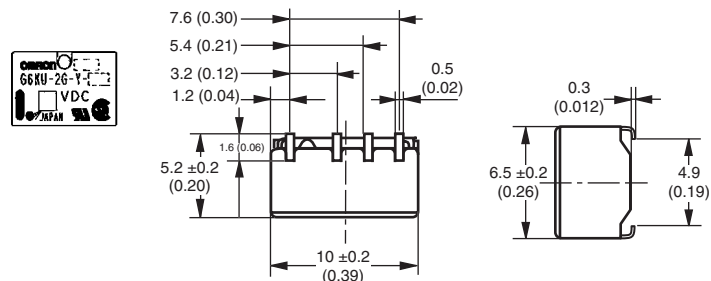

Terminal arrangement/
Internal connections

Mounting pads
(top view)

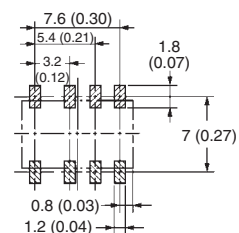
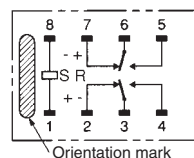

G6KU-2P-Y

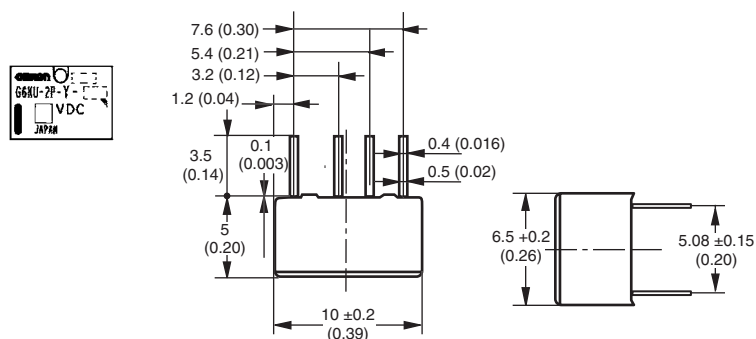

Terminal arrangement/
Internal connections
(top view)

Mounting pads
(top view)

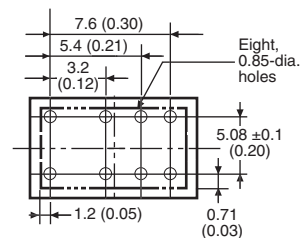
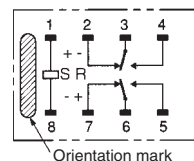

■ Accessories

Relays in tube packing are arranged so that the orientation mark of each Relay is on the left side. Be sure to reference Relay orientation when mounting the Relay to the PCB.

| Tube packing | Standard nomenclature | 50 pcs per anti-static tube |
|--------------|---|-----------------------------|
| Tape packing | When ordering, add "TR" before the rated coil voltage (e.g., G6K-2G-TR-DC5). Note: TR is not part of the relay model number and will not be marked on the relay. | |

■ Tape and Reel Dimensions

- Tape type: ETX7200 (EIAJ - Electronic Industrial Association of Japan)
- 16 mm tape meets EIA Standards
 - 5.6 mm pocket depth
 - 12 mm pitch
 - 4 mm sprocket pitch
- Reel type: RPM-16D (EIAJ), 330 mm
- Relays per reel: 900

1. Direction of Relay Insertion

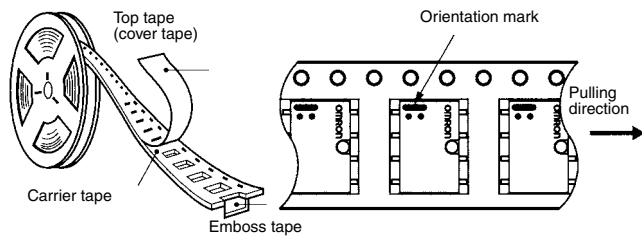

2. Reel Dimensions

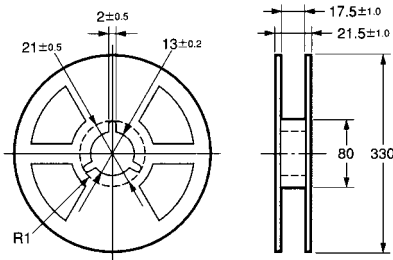

3. Carrier Tape Dimensions

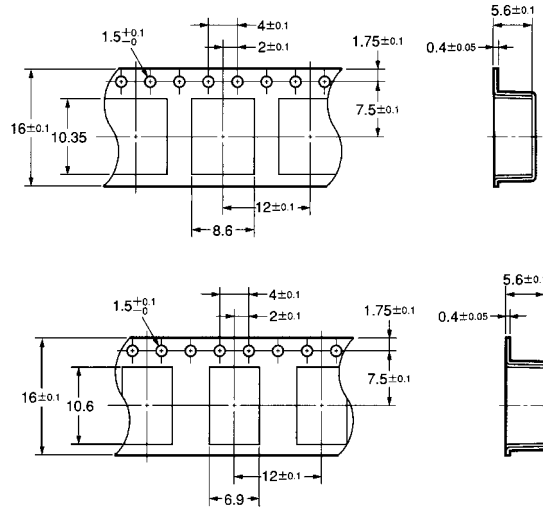

Precautions

■ Correct Use

Handling

Do not unpack the relay until mounting it.

Soldering

Solder: JIS Z3282, H63A or equivalent

Soldering temperature: Approx. 250°C (260°C if the DWS method is used)

Soldering time: Approx. 5 s max. (approx. 2 s for the first time and approx. 3 s for the second time if the DWS method is used)

Be sure to make a molten solder level adjustment so that the solder will not overflow on the PCB.

Claw Securing Force During Automatic Mounting

During automatic insertion of Relays, make sure to set the securing force of each claw to the following so that the Relays characteristics will be maintained.

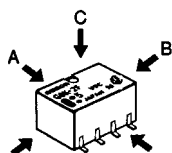

Direction A: 1.96 N
 Direction B: 4.90 N
 Direction C: 1.96 N

Environmental Conditions During Operation, Storage, and Transportation

It is best to keep the relay in its packaging in a controlled environment until it is ready for mounting.

If the Relay is stored for a long time in an adverse environment with high temperature, high humidity, organic gases, or sulfide gases, sulfide or oxide films will form on the contact surfaces. These films may result in unstable contact, contact problems, or functional problems. Therefore, operate, store, or transport the product under specified environmental conditions.

Latching Relay Mounting

Make sure that the vibration or shock that is generated from other devices, such as relays in operation, on the same panel and imposed on the Latching Relay does not exceed the rated value, otherwise the Latching Relay that has been set may be reset or vice versa. The Latching Relay is reset before shipping. If excessive vibration or shock is imposed, however, the Latching Relay may be set accidentally. Be sure to apply a reset signal before use.

Maximum Allowable Voltage

The maximum allowable voltage of the coil can be obtained from the coil temperature increase and the heat-resisting temperature of coil insulating sheath material. (Exceeding the heat-resisting temperature may result in burning or short-circuiting.) The maximum allowable voltage also involves important restrictions which include the following:

- Must not cause thermal changes in or deterioration of the insulating material.
- Must not cause damage to other control devices.
- Must not cause any harmful effect on people.
- Must not cause fire.

Therefore, be sure to use the maximum allowable voltage as specified in the catalog.

As a rule, the rated voltage must be applied to the coil. A voltage exceeding the rated value, however, can be applied to the coil provided that the voltage is less than or equal to the maximum allowable voltage. It must be noted that continuous voltage application to the coil will cause a coil temperature increase which may affect characteristics such as electrical life and coil insulation.

Coating

The Relay mounting on the PCB may be coated or washed but do not apply silicone coating or detergent containing silicone, otherwise the silicone coating or detergent may remain on the surface of the Relay.

PCB Mounting

If two or more Relays are closely mounted with the long sides of the Relays facing each other and soldering is performed with infrared radiation, the solder may not be properly exposed to the infrared rays. Be sure to keep the proper distance between adjacent Relays as shown below to insure formation of good solder joints.

G6K-2G

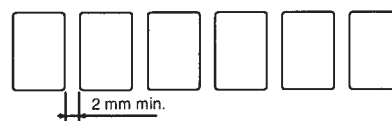

G6K-2F

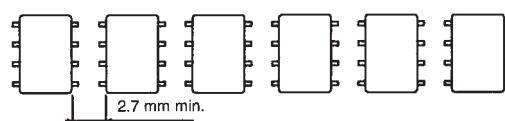

Two or more Relays may be mounted as closely as desired with the short sides of the Relays facing each other.

ALL DIMENSIONS SHOWN ARE IN MILLIMETERS. To convert millimeters into inches, divide by 25.4

OMRON

OMRON ELECTRONICS LLC

One Commerce Drive
Schaumburg, IL 60173

847-882-2288

OMRON CANADA, INC.

885 Milner Avenue
Toronto, Ontario M1B 5V8

416-286-6465

OMRON ON-LINE

Global - <http://www.omron.com>
USA - <http://www.omron.com/oei>
Canada - <http://www.omron.ca>