

High-frequency Relay G6W

Surface-mountable 5 GHz Band Miniature SPDT High-frequency Relay

- Superior high-frequency characteristics, such as an isolation of 60 dB min., insertion loss of 0.2 dB max., and V.S.W.R of 1.2 max. at 5 GHz (50 Ω).
- High-frequency characteristics obtained by adopting tri-plate micro strip line design.
- Small size at 20 x 9.4 x 8.9 mm (L x W x H).
- Y-shape terminal arrangement simplifies wiring to PCBs.
- SMT and latching versions available.

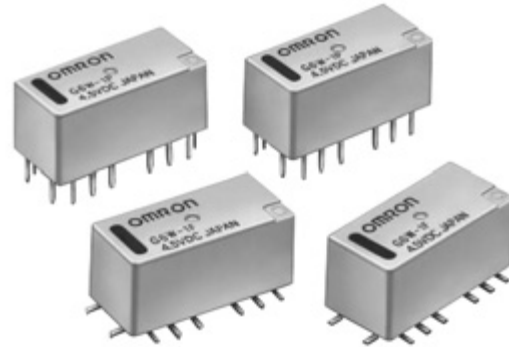

Ordering Information

Classification				Non latching	Single-coil latching	Dual-coil latching
SPDT	Fully sealed	Through-hole terminal	Y-shape terminal	G6W-1P	G6WU-1P	G6WK-1P
		Surface-mount terminal	Y-shape terminal	G6W-1F	G6WU-1F	G6WK-1F

Note: When ordering, add the rated coil voltage to the model number.
 Example: G6W-1P 12 VDC
 └── Rated coil voltage

Model Number Legend:

G6W - -
 1 2 3 4 5

1. Relay function

- None: Non-latching
- U: Single-coil latching
- K: Dual-coil latching

2. Contact form

- 1: SPDT

3. Terminal shape

- F: Surface-mount terminals
- P: PCB through-hole terminals

4. Terminal Structure

- None: Y-shape terminal (standard)

5. Contact Arrangement

- None: Standard contact arrangement
- R: Reverse contact arrangement

Typical Applications

- Mobile phone base station (W-CDMA, UMTS, CDMA-2000, PCS)
- Wireless LAN
- Measurement devices

Specifications

■ Contact Ratings

Item	Load	Resistive load
Rated load		10 mA at 30 VAC 10 mA at 30 VDC 2.5 GHz, 50 Ω, 10 W (See note)
Rated carry current		0.5 A
Max. switching voltage		30 VDC, 30 VAC
Max. switching current		0.5 A

■ High-frequency Characteristics

Item	Frequency	2.0 GHz	2.5 GHz	5.0 GHz
Isolation		65 dB min.	60 dB min.	40 dB min.
Insertion loss		0.2 dB max.		0.4 dB min
V.SWR		1.2 max.		15 dB min.
Max. carry power		20 W (See note)		
Max. switching power		10 W (See note)		

Note: 1. The above values are initial values.

2. These values are for a load with V.SWR ≤ 1.2 at an impedance of 50 Ω.

■ Coil Ratings

Non-latching Relays (G6W-1F, G6W-1P)

Rated voltage	3 VDC	4.5 VDC	9 VDC	12 VDC	24 VDC
Rated current	66.7 mA	44.4 mA	22.2 mA	16.7 mA	8.3 mA
Coil resistance	45 Ω	101 Ω	405 Ω	720 Ω	2,880 Ω
Must operate voltage	80% of max. of rated voltage				
Must release voltage	10% min. of rated voltage				
Maximum voltage	150% of rated voltage				
Power consumption	Approx. 200 mW				

Single-coil Latching Relays (G6WU-1F, G6WU-1P)

Rated voltage	9 VDC	12 VDC
Rated current	22.2 mA	16.7 mA
Coil resistance	405 Ω	720 Ω
Must set voltage	80% max. of rated voltage	
Must reset voltage	80% max of rated voltage	
Maximum voltage	150% of rated voltage	
Power consumption	Approx. 200 mW	

Dual-coil Latching Relays (G6WK-1F, G6WK-1P)

Rated voltage	3 VDC	4.5 VDC	9 VDC	12 VDC	24 VDC
Rated current	120 mA	80 mA	40 mA	30 mA	15 mA
Coil resistance	25 Ω	56 Ω	225 Ω	400 Ω	1,600 Ω
Must set voltage	80% max. of rated voltage				
Must reset voltage	80% max. of rated voltage				
Maximum voltage	150% of rated voltage				
Power consumption	Approx. 360 mW				

Note: 1. The rated current and coil resistance are measured at a coil temperature of 23°C with a tolerance of ± 10%.

2. The operating characteristics are measured at a coil temperature of 23°C.

3. The maximum voltage is the highest voltage that can be imposed on the relay coil.

Characteristics

Item	Classification Model	Non-latching	Single-coil latching	Dual-coil latching
		G6W-1F, G6W-1P	G6WU-1F, G6WU-1P	G6WK-1F, G6WK-1P
Contact resistance (See note 1)		100 mΩ max.		
Operate (set) time (See note 2)		10 ms max. (Approx. 3.5 ms)	10 ms max. (Approx. 2.5 ms)	
Release (reset) time (See note 2)		10 ms max. (Approx. 2.5 ms)		
Minimum set/reset signal width		-----	12 ms	
Insulation resistance (See note 3)		1,000 MΩ min. (at 500 VDC)		
Dielectric strength	Coil and contacts	1,000 VAC, 50/60 Hz for 1 min		
	Coil and ground, contacts and ground	500 VAC, 50/60 Hz for 1 min		
	Contact of same polarity	500 VAC, 50/60 Hz for 1 min		
Vibration resistance	Destruction	10 to 55 Hz, 1.5-mm double amplitude		
	Malfunction	10 to 55 Hz, 2-mm double amplitude		
Shock resistance	Destruction	1,000 m/s ²		
	Malfunction	500 m/s ²		
Endurance	Mechanical	1,000,000 operations min. (at 36,000 operations/hour)		
	Electrical	300,000 operations min. (with a rated load at 1,800 operations/hour)		
Ambient temperature		Operating: -40°C to 70°C (with no icing or condensation)		
Ambient humidity		Operating: 5% to 85%		
Weight		Approx. 3 g		

- Note:**
- The contact resistance was measured with 10 mA at 1 VDC with a fall-of-potential method.
 - Values in parentheses are actual values.
 - The insulation resistance was measured with a 500-VDC Megger Tester applied to the same parts as those used for checking the dielectric strength.
 - The above values are initial values.

Engineering Data

Ambient Temperature vs. Maximum Voltage

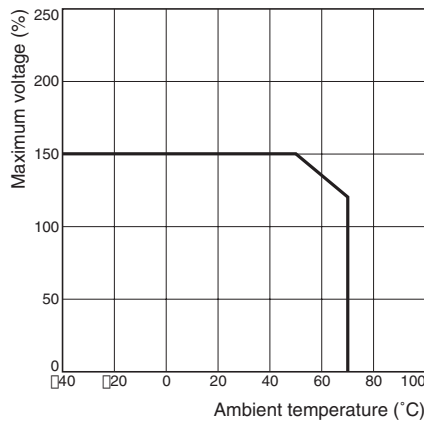

Note: "Maximum voltage" is the maximum voltage that can be applied to the relay coil.

Ambient Temperature vs. Must Set or Must Reset Voltage

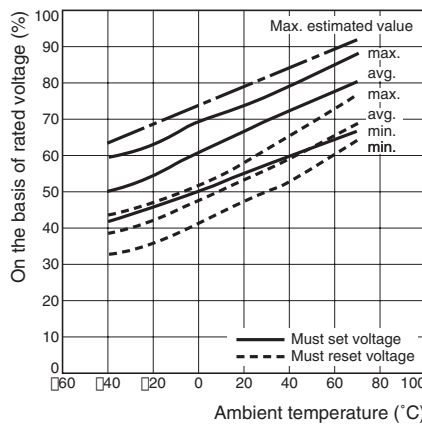

Shock Malfunction

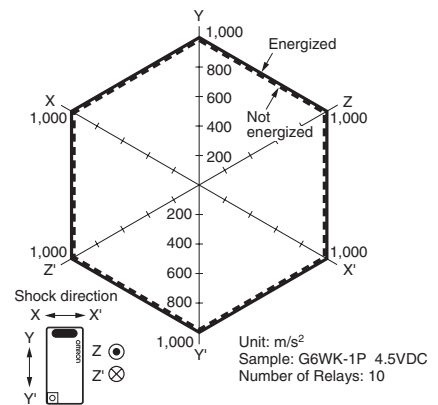

Conditions: Shock is applied in ±X, ±Y, and ±Z directions three times each with and without energizing the relays to check the number of contact malfunctions.

**Electrical Endurance
(With Must Set and Must Reset
Voltage)**

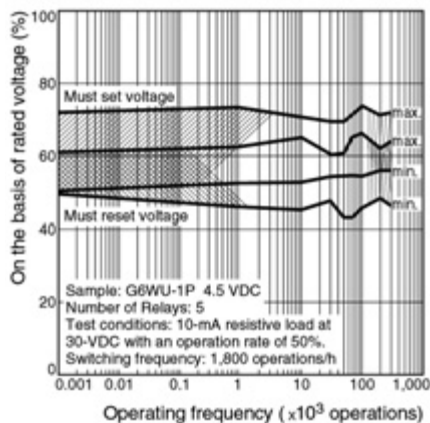

**Electrical Endurance
(With Must Set and Must Reset
Voltage)**

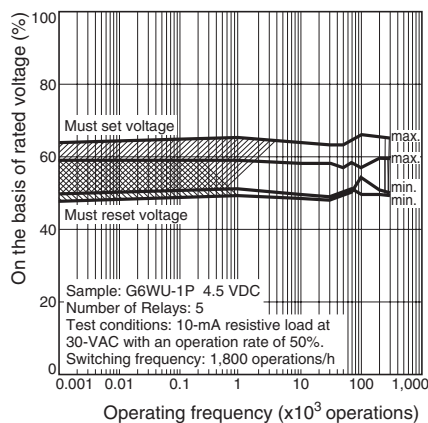

**Electrical Endurance
(Contact Resistance)**

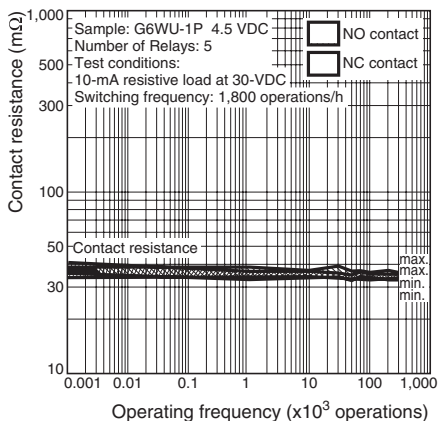

**Electrical Endurance
(Contact Resistance)**

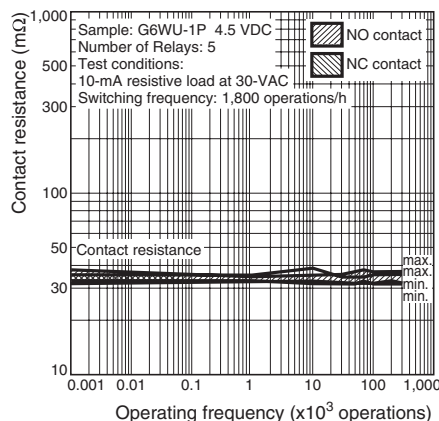

External Magnetic Interference

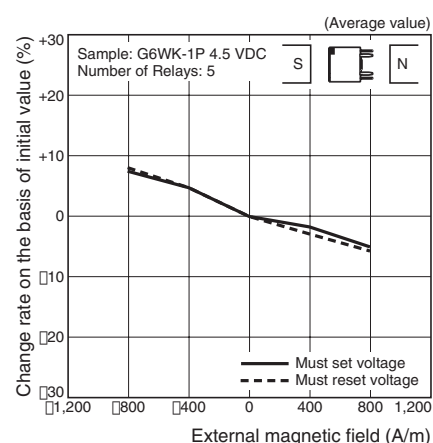
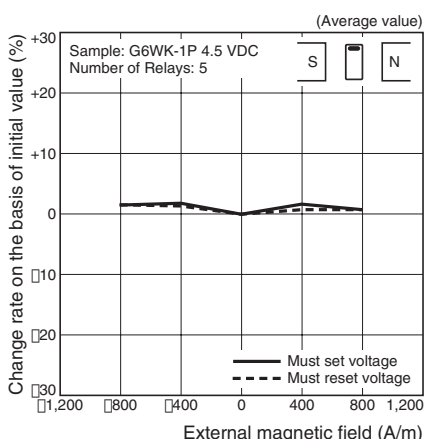
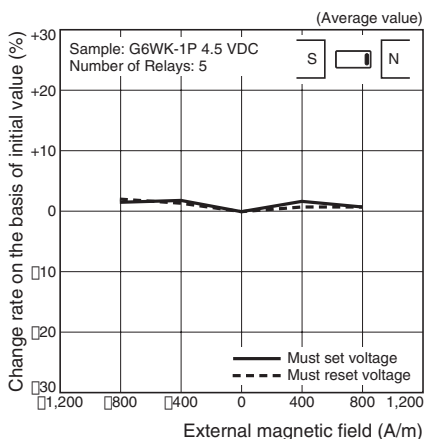

High-frequency Characteristics (Isolation)

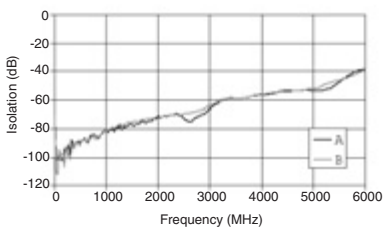

High-frequency Characteristics (Insertion Loss)

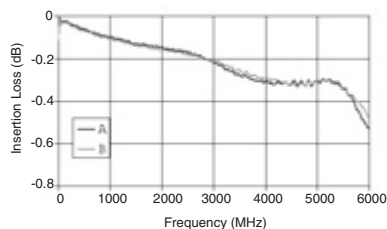

High-frequency Characteristics (Return Loss)

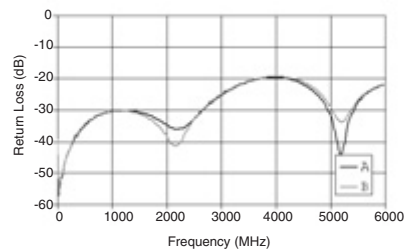

Must Set and Must Reset Time Distribution (see note).

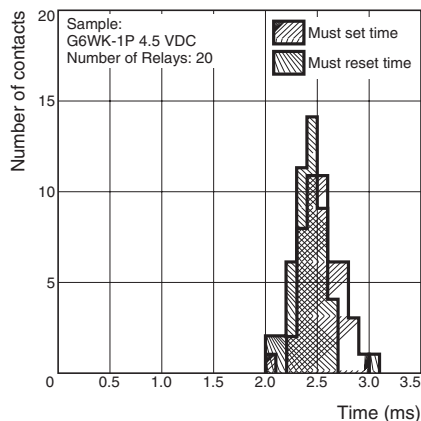

Must Set and Must Reset Bounce Time Distribution (see note).

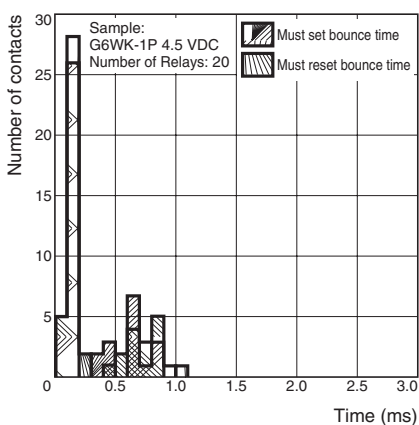

Note: The tests were conducted at an ambient temperature of 23°C.

Dimensions

Unit: mm (inch)

**G6W-1F
G6WU-1F**

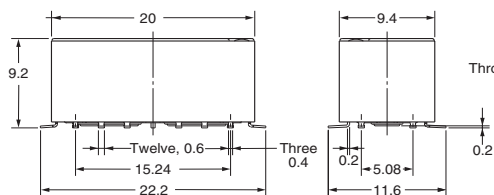
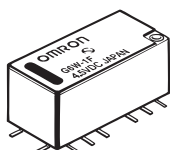

Mounting Pads (Top View)

Tolerance: ± 0.1 mm

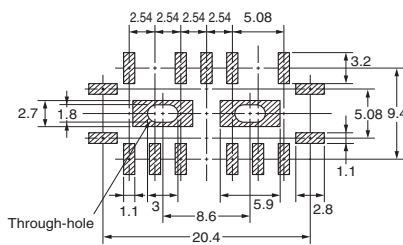

Terminal Arrangement/ Internal Connections (Top View)

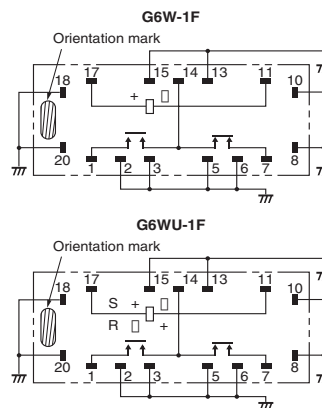

Note: Each value has a tolerance of ± 0.3 mm.

**G6W-1P
G6WU-1P**

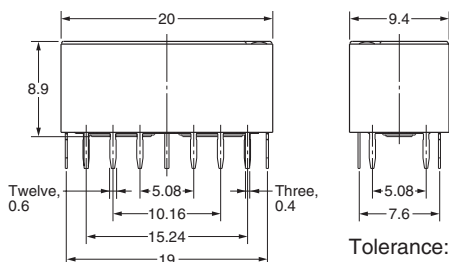
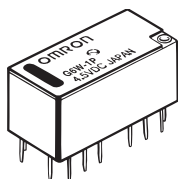

**Mounting Holes
(Bottom View)**
Tolerance: ± 0.1 mm

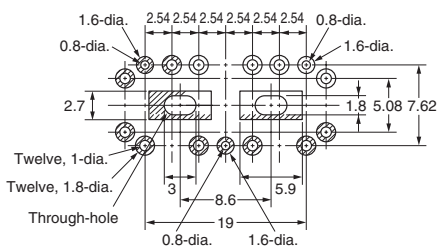

**Terminal Arrangement/
Internal Connections
(Bottom View)**

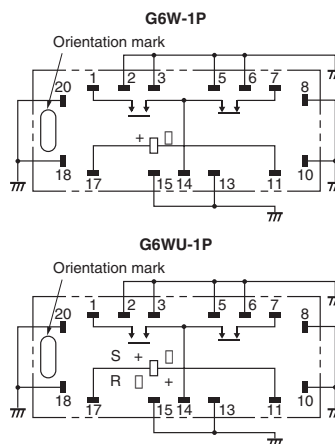

G6WK-1F

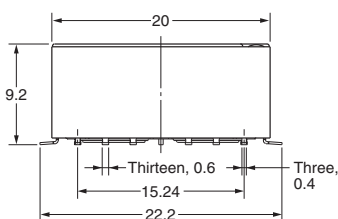
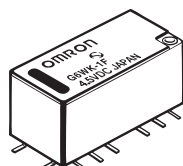

**Mounting Pads
(Top View)**
Tolerance: ± 0.1 mm

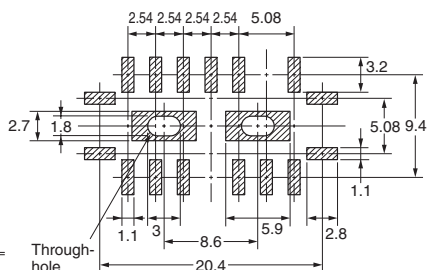

**Terminal Arrangement/
Internal Connections
(Top View)**

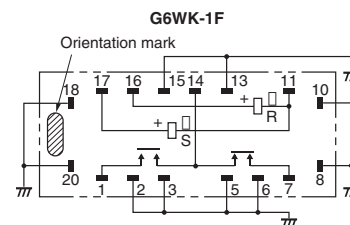

G6WK-1P

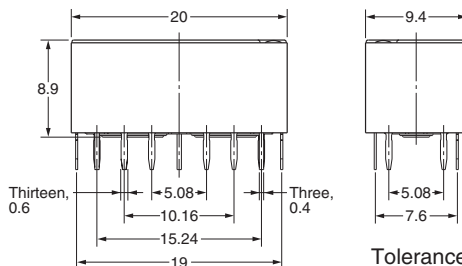
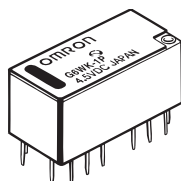

**Mounting Holes
(Bottom View)**
Tolerance: ± 0.1 mm

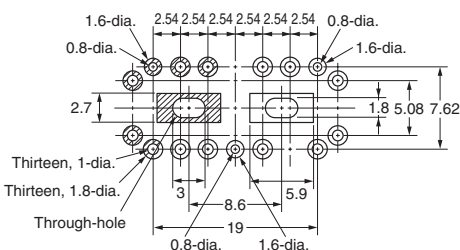

**Terminal Arrangement/
Internal Connections
(Bottom View)**

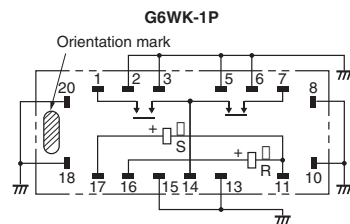

Recommended Soldering Method

■ IRS Method (for Surface-mount Terminal Relays)

- Temperature indicates the surface temperatures of the PCB.

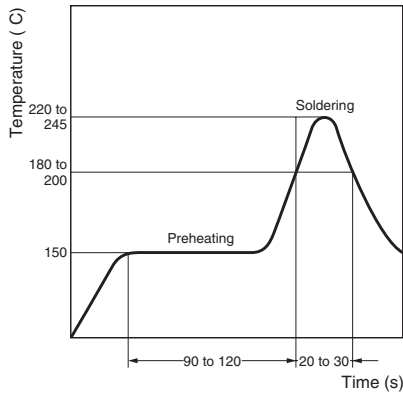

- The thickness of cream solder to be applied should be within a range between 150 μm and 200 μm on Omron's recommended PCB pattern.

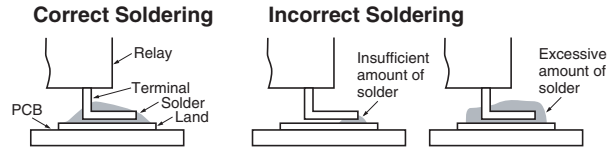

Visually check that the Relay is properly soldered.

Precautions

■ Correct Use

High-frequency Characteristics Measurement Method and Substrate to be Measured

High Frequency characteristics for G6W are measured as shown below.

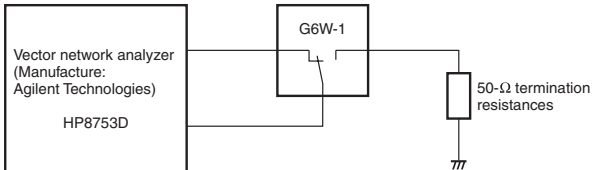

Through-hole Substrate

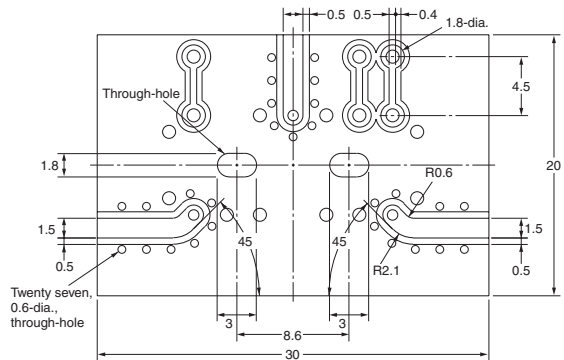

Undersurface of relay

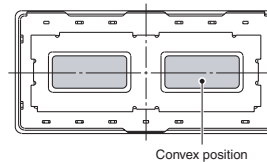

SMD-type substrate

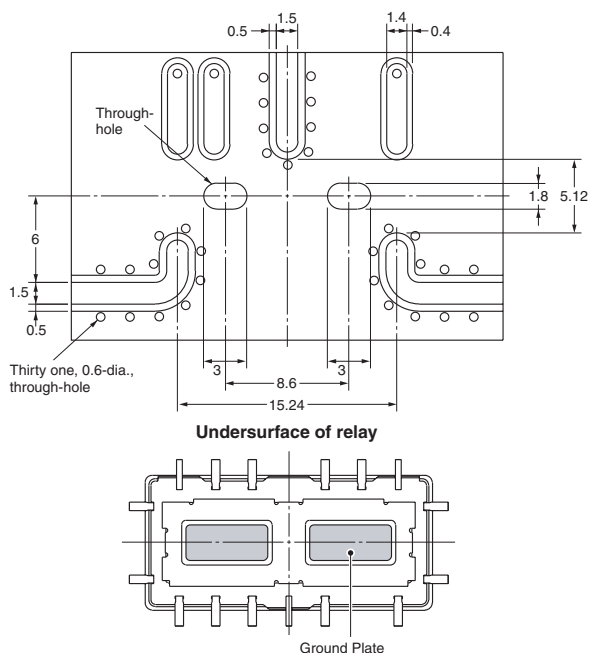

Note: To guarantee isolation characteristics, solder the ground plates to the PCB substrate. It is recommended that the ground plates are soldered after the main reflow process.

Base plate for high-frequency characteristic compensation

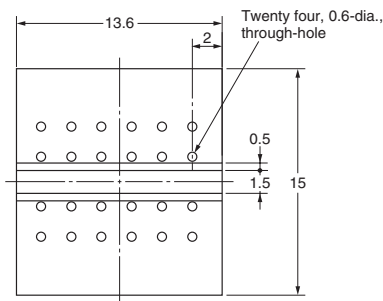

Note: The above compensation plate is used to measure the loss by the relay. The relay loss is determined by subtracting the data measured for a compensation base plate from those for a high-frequency characteristics measuring substrate mounted with a relay.

Handling

Leave the relays packed until just prior to mounting them.

Soldering

Solder: JIS Z3282, H63A

Soldering temperature: Approx. 250°C (at 260°C if the DWS method is used).

Soldering time: Approx. 5 s max. (approx 2 s for the first time and approx 3 s for the second time if the DWS method is used).

Be sure to adjust the level of the molten solder so that the solder will not overflow onto the PCB.

Claw Securing Force During Automatic Insertion

During automatic insertion of relays, make sure to set the securing force of the claws to the following values so that the relay characteristics will be maintained.

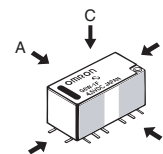

Direction A: 4.90 N max.
 Direction B: 9.80 N max.
 Direction C: 9.80 N max.

Secure the claws to the area indicated by shading. Do not attach them to the center area or to only part of the Relay.

Environmental Conditions During Operation, Storage, and Transportation

Protect the relays from direct sunlight and keep the relays under normal temperature, humidity and pressure.

Latching Relay Mounting

Make sure that the vibration or shock that is generated from other devices, such as relays in operation, on the same panel and imposed on the Latching Relay does not exceed the rated value, otherwise the Latching Relay that has been set may be reset or vice versa. The Latching Relay is reset before shipping. If excessive vibration or shock is imposed, however, the Latching Relay may be set accidentally. Be sure to apply a reset signal before use.

Coating

Relays mounted on PCBs may be coated or washed. Do not apply silicone coating or detergent containing silicone, otherwise the silicone coating or detergent may remain on the surface of the relays.

ALL DIMENSIONS SHOWN ARE IN MILLIMETERS. To convert millimeters into inches, divide by 25.4

OMRON

OMRON ELECTRONICS LLC

One Commerce Drive
Schaumburg, IL 60173

847-882-2288

OMRON CANADA, INC.

885 Milner Avenue
Toronto, Ontario M1B 5V8

416-286-6465

OMRON ON-LINE

Global - <http://www.omron.com>
USA - <http://www.omron.com/oei>
Canada - <http://www.omron.ca>

Cat. No. GC RLY8

3/03

Specifications subject to change without notice

Printed in USA