

High-frequency Relay

G6Z

Miniature 2.6-GHz-Band, SPDT, High-frequency Relay

- Superior high-frequency characteristics include an isolation of 30 dB min., 60-65 dB isolation at 900 MHz, insertion loss of 0.5 dB max., and V.SWR of 1.5 max. at 2.6 GHz.
- Triplate micro stripline technology assures superior high-frequency characteristics.
- Miniature dimensions of 20 × 8.6 × 8.9 mm (L × W × H).
- Available models include single-coil latching (200 mW), dual coil latching (360 mW), and models with reverse contact arrangement.
- Series includes versions with an E-shape terminal structure, and models with a Y-shape terminal structure, allowing greater freedom with PCB design.
- Models with 75-Ω impedance and models with 50-Ω impedance are also available.
- Surface mount relays available in tube packaging or tape-and-reel packaging.

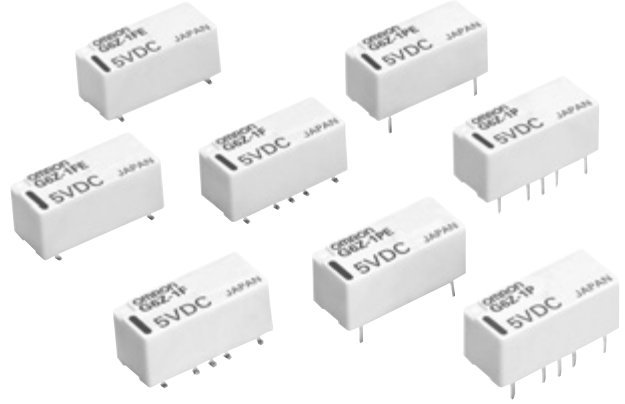

Ordering Information

Model Number Legend:

G6Z-□-□□□-□□
 1 2 3 4 5 6

1. Relay Function

None: Non-latching
 U: Single coil latching
 K: Dual coil latching

2. Contact Form

1: SPDT

3. Terminal Shape

F: Surface mount terminals
 P: PCB through-hole terminals

4. Terminal Structure

None: Y-shape terminal
 E: E-shape terminal

5. Characteristic Impedance

None: 75 Ω
 A: 50 Ω

6. Contact Arrangement

None: Standard contact arrangement
 R: Reverse contact arrangement

■ Standard Models with PCB Through-hole Terminals

| Classification | Structure | Contact form | Terminal arrangement | Characteristic impedance | Rated coil voltage | Model |
|----------------------|--------------|--------------|------------------------------|--------------------------|------------------------------|------------|
| Non-latching | Fully sealed | SPDT | E-shape | 75 Ω | 3, 4.5, 5, 9, 12, and 24 VDC | G6Z-1PE |
| | | | | 50 Ω | 3, 4.5, 5, 9, 12, and 24 VDC | G6Z-1PE-A |
| | | | Y-shape | 75 Ω | 3, 4.5, 5, 9, 12, and 24 VDC | G6Z-1P |
| | | | | 50 Ω | 3, 4.5, 5, 9, 12, and 24 VDC | G6Z-1P-A |
| Single coil latching | | | E-shape | 75 Ω | 3, 4.5, 5, 9, 12, and 24 VDC | G6ZU-1PE |
| | | | | 50 Ω | 3, 4.5, 5, 9, 12, and 24 VDC | G6ZU-1PE-A |
| | | | Y-shape | 75 Ω | 3, 4.5, 5, 9, 12, and 24 VDC | G6ZU-1P |
| | | | | 50 Ω | 3, 4.5, 5, 9, 12, and 24 VDC | G6ZU-1P-A |
| Dual coil latching | E-shape | 75 Ω | 3, 4.5, 5, 9, 12, and 24 VDC | G6ZK-1PE | | |
| | | 50 Ω | 3, 4.5, 5, 9, 12, and 24 VDC | G6ZK-1PE-A | | |
| | Y-shape | 75 Ω | 3, 4.5, 5, 9, 12, and 24 VDC | G6ZK-1P | | |
| | | 50 Ω | 3, 4.5, 5, 9, 12, and 24 VDC | G6ZK-1P-A | | |

■ Standard Models with Surface-mounting Terminals

| Classification | Structure | Contact form | Terminal arrangement | Characteristic impedance | Rated coil voltage | Model |
|----------------------|--------------|--------------|------------------------------|--------------------------|------------------------------|------------|
| Non-latching | Fully sealed | SPDT | E-shape | 75 Ω | 3, 4.5, 5, 9, 12, and 24 VDC | G6Z-1FE |
| | | | | 50 Ω | 3, 4.5, 5, 9, 12, and 24 VDC | G6Z-1FE-A |
| | | | Y-shape | 75 Ω | 3, 4.5, 5, 9, 12, and 24 VDC | G6Z-1F |
| | | | | 50 Ω | 3, 4.5, 5, 9, 12, and 24 VDC | G6Z-1F-A |
| Single coil latching | | | E-shape | 75 Ω | 3, 4.5, 5, 9, 12, and 24 VDC | G6ZU-1FE |
| | | | | 50 Ω | 3, 4.5, 5, 9, 12, and 24 VDC | G6ZU-1FE-A |
| | | | Y-shape | 75 Ω | 3, 4.5, 5, 9, 12, and 24 VDC | G6ZU-1F |
| | | | | 50 Ω | 3, 4.5, 5, 9, 12, and 24 VDC | G6ZU-1F-A |
| Dual coil latching | E-shape | 75 Ω | 3, 4.5, 5, 9, 12, and 24 VDC | G6ZK-1FE | | |
| | | 50 Ω | 3, 4.5, 5, 9, 12, and 24 VDC | G6ZK-1FE-A | | |
| | Y-shape | 75 Ω | 3, 4.5, 5, 9, 12, and 24 VDC | G6ZK-1F | | |
| | | 50 Ω | 3, 4.5, 5, 9, 12, and 24 VDC | G6ZK-1F-A | | |

Note: When ordering tape and reel packaging (surface-mount models), add “-TR” to the model number, (example: G6Z-1FE“TR”-DC12) “-TR” does not appear on the relay itself.

Application Examples

These Relays can be used for switching signals in media equipment.

- **Wire communications:**

Cable TV (STB and broadcasting infrastructure), cable modems, and VRS (video response systems)

- **Wireless communications:**

Transceivers, ham radios, car telephones, ETC, ITS, high-level TV, satellite broadcasting, text multiplex broadcasting, pay TV, mobile phone stations, TV broadcasting facilities, and community antenna systems

- **Public equipment:**

TVs, TV games, satellite radio units, car navigation systems

- **Industrial equipment:**

Measuring equipment, test equipment, and multiplex transmission devices

Specifications

■ Contact Ratings

| | |
|------------------------|--|
| Load type | Resistive load |
| Rated load | 10 mA at 30 VAC; 10 mA at 30 VDC; 10 W at 900 MHz (See note) |
| Rated carry current | 0.5 A |
| Max. switching voltage | 30 VAC, 30 VDC |
| Max. switching current | 0.5 A |

Note: This value is for an impedance of 50 Ω or 75 Ω with a V.SWR of 1.2 max.

■ High-frequency Characteristics

| Frequency | | 900 MHz | | | | 2.6 GHz | | | |
|---|-------------|-------------------|---------|---------------|---------|--------------|------------|---------------|------------|
| Terminal type | | Through hole | | Surface mount | | Through hole | | Surface mount | |
| Terminal structure | | E-shape | Y-shape | E-shape | Y-shape | E-shape | Y-shape | E-shape | Y-shape |
| Isolation | 75 Ω | 65 dB min. | | 60 dB min. | | 35 dB min. | 45 dB min. | 30 dB min. | 40 dB min. |
| | 50 Ω | 60 dB min. | | | | | | | |
| Insertion loss (not including substrate loss) | 75 Ω | 0.2 dB max. | | | | 0.5 dB max. | | | |
| | 50 Ω | 0.1 dB max. | | | | 0.3 dB max. | | | |
| V.SWR | 75 Ω | 1.2 max. | | | | 1.5 max. | | | |
| | 50 Ω | 1.1 max. | | | | 1.3 max. | | | |
| Return loss | 75 Ω | 20.8 dB max. | | | | 14.0 dB max. | | | |
| | 50 Ω | 26.4 dB max. | | | | 17.7 dB max. | | | |
| Maximum carry power | | 10 W (See note 2) | | | | | | | |
| Maximum switching power | | 10 W (See note 2) | | | | | | | |

Note: 1. The above values are initial values.

2. These values are for an impedance of 50 Ω or 75 Ω with a V.SWR of 1.2 max.

■ Coil Ratings

The operating characteristics are measured at a coil temperature of 23°C.

Non-latching, Standard and Reverse-contact Models

| Rated voltage (VDC) | Rated current (mA) | Coil resistance (Ω , $\pm 10\%$) | Must operate voltage (VDC) | Must dropout voltage (VDC) | Maximum voltage (VDC) at 70°C max. | Power consumption (mW) |
|---------------------|--------------------|---|----------------------------|----------------------------|------------------------------------|------------------------|
| 3 | 66.7 | 45 | 2.25 | 0.3 | 4.5 | Approx. 200 |
| 4.5 | 44.4 | 101.3 | 3.375 | 0.45 | 6.75 | |
| 5 | 40.0 | 125 | 3.75 | 0.5 | 7.5 | |
| 9 | 22.2 | 405 | 6.75 | 0.9 | 13.5 | |
| 12 | 16.7 | 720.4 | 9 | 1.2 | 18 | |
| 24 | 8.3 | 2880.1 | 18 | 2.4 | 36 | |

Single Coil Latching Models G6ZU-1P(E), G6ZU-1F(E)

| Rated voltage (VDC) | Rated current (mA) | Coil resistance (Ω , $\pm 10\%$) | Must set voltage (VDC) | Must reset voltage (VDC) | Maximum voltage (VDC) at 70°C max. | Power consumption (mW) |
|---------------------|--------------------|---|------------------------|--------------------------|------------------------------------|------------------------|
| 3 | 66.7 | 45 | 2.25 | 2.25 | 150% of rated voltage | Approx. 200 |
| 4.5 | 44.4 | 101.3 | 3.375 | 3.375 | | |
| 5 | 40.0 | 125 | 3.75 | 03.75 | | |
| 9 | 22.2 | 405 | 6.75 | 6.75 | | |
| 12 | 16.7 | 720.4 | 9 | 9 | | |
| 24 | 8.3 | 2880.1 | 18 | 18 | | |

Dual Coil Latching Models G6ZK-1P(E), G6ZK-1F(E)

| Rated voltage (VDC) | Rated current (mA) | Coil resistance (Ω , $\pm 10\%$) | Must set voltage (VDC) | Must reset voltage (VDC) | Maximum voltage (VDC) at 70°C max. | Power consumption (mW) |
|---------------------|--------------------|---|------------------------|--------------------------|------------------------------------|------------------------|
| 3 | 120 | 25 | 2.25 | 2.25 | 150% of rated voltage | Approx. 360 |
| 4.5 | 80 | 56.2 | 3.375 | 3.375 | | |
| 5 | 72 | 69.4 | 3.75 | 03.75 | | |
| 9 | 40 | 224.9 | 6.75 | 6.75 | | |
| 12 | 30 | 400 | 9 | 9 | | |
| 24 | 15 | 1599.9 | 18 | 18 | | |

- Note:**
1. The rated current and coil resistance are measured at a coil temperature of 23°C with a tolerance of $\pm 10\%$.
 2. The operating characteristics are measured at a coil temperature of 23°C.
 3. The maximum voltage is the highest voltage that can be imposed on the relay coil instantaneously.

Characteristics

| Item | | Non-latching models | Single coil latching models | Dual coil latching models |
|------------------------------------|--------------------------------------|--|-----------------------------|---------------------------|
| | | G6Z-1P(E), G6Z-1F(E) | G6ZU-1P(E), G6ZU-1F(E) | G6ZK-1P(E), G6ZK-1F(E) |
| Contact resistance (See note 2) | | 100 mΩ max. | | |
| Operating (set) time (See note 3) | | 10 ms max. (approx. 3.5 ms) | 10 ms max. (approx. 2.5 ms) | |
| Release (reset) time (See note 3) | | 10 ms max. (approx. 2.5 ms) | | |
| Set/reset time | | --- | 12 ms | |
| Insulation resistance (See note 4) | | 100 MΩ min. (at 500 VDC) | | |
| Dielectric strength | Coil and contacts | 1,000 VAC, 50/60 Hz for 1 min. | | |
| | Coil and ground, contacts and ground | 500 VAC, 50/60 Hz for 1 min. | | |
| | Contacts of same polarity | 500 VAC, 50/60 Hz for 1 min. | | |
| Vibration resistance | Mechanical durability | 10 to 55 to 10 Hz, 0.75-mm single amplitude (1.5-mm double amplitude) | | |
| | Malfunction durability | 10 to 55 to 10 Hz, 0.75-mm single amplitude (1.5-mm double amplitude) | | |
| Shock resistance | Mechanical durability | 1,000 m/s ² | | |
| | Malfunction durability | 500 m/s ² | | |
| Service life | Mechanical | 1,000,000 operations min. (at 36,000 operations/hour) | | |
| | Electrical | 300,000 operations min. (30 VAC, 10 mA/30 VDC, 10 mA), 100,000 operations min. (900 MHz, 10 W) at a switching frequency of 1,800 operations/hour | | |
| Ambient temperature | | Operating: -40°C to 70°C (-40°F to 158°F) (with no icing or condensation) | | |
| Ambient humidity | | Operating: 5% to 85% RH | | |
| Weight | | Approx. 2.8 g | | |

- Note:**
- The above values are initial values.
 - The contact resistance was measured with 10 mA at 1 VDC with a voltage drop method.
 - Values in parentheses are actual values.
 - The insulation resistance was measured with a 500-VDC megohmmeter applied to the same parts as those used for checking the dielectric strength.

Engineering Data

Ambient Temperature vs. Maximum Voltage

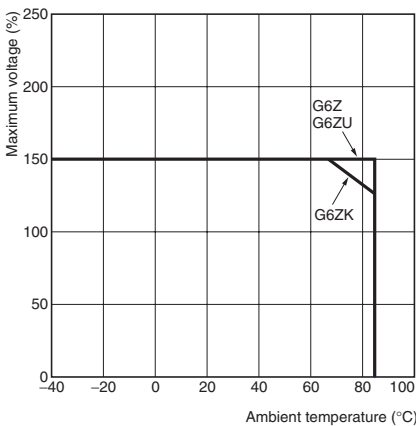

Ambient Temperature vs. Must Operate or Must Release Voltage

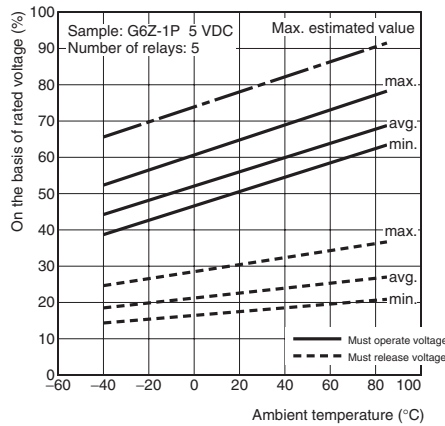

Shock Malfunction

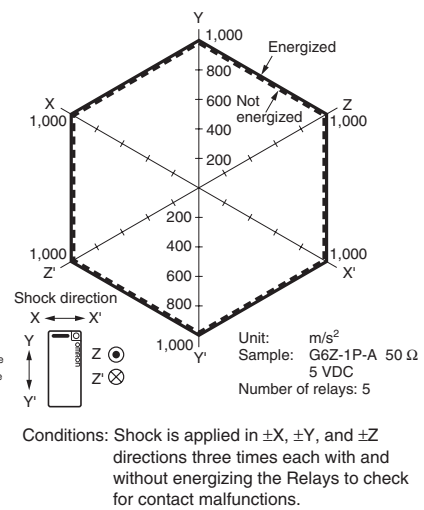

Electrical Endurance (with Must Operate and Must Release Voltage)

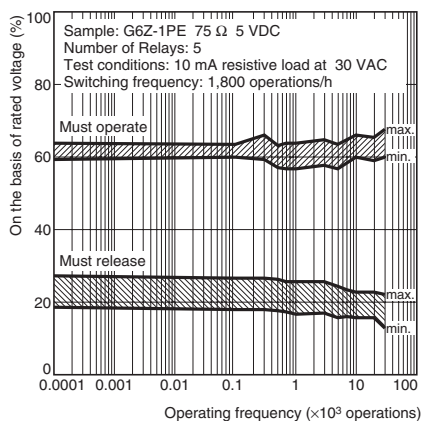

Electrical Endurance (with Must Operate and Must Release Voltage)

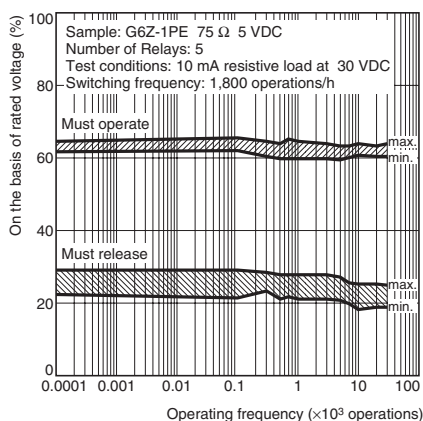

Electrical Endurance (Contact Resistance)

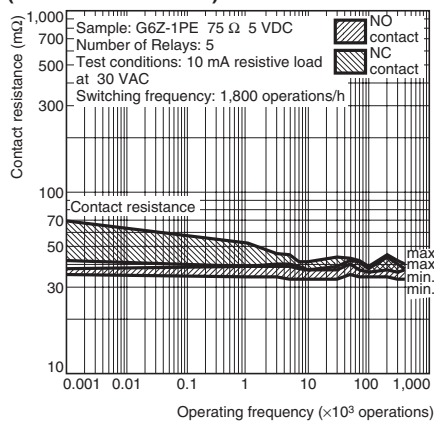

Electrical Endurance (Contact Resistance)

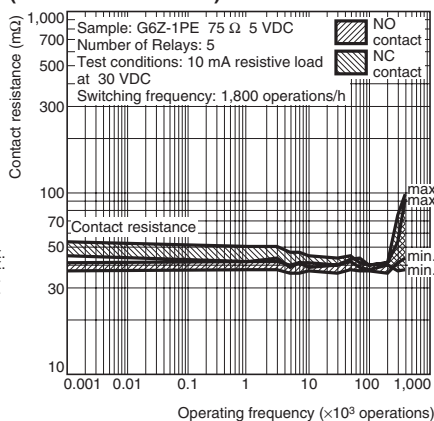

External Magnetic Interference

(Average value)

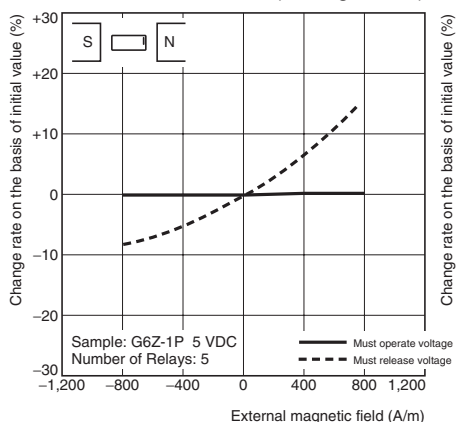

(Average value)

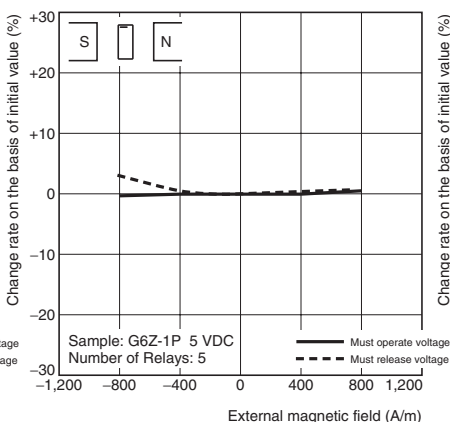

(Average value)

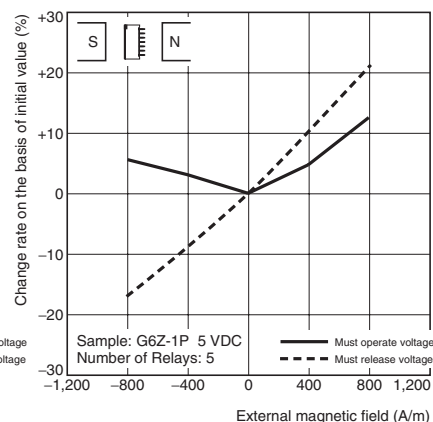

High-frequency Characteristics at 75 Ω (Isolation)

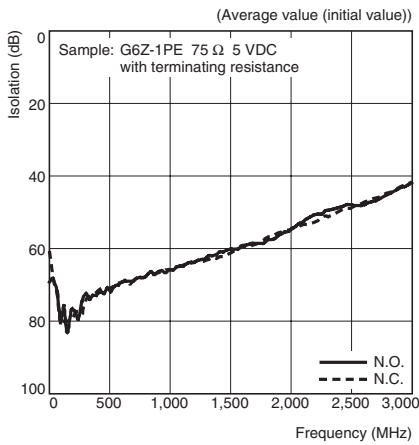

High-frequency Characteristics at 75 Ω (Insertion Loss)

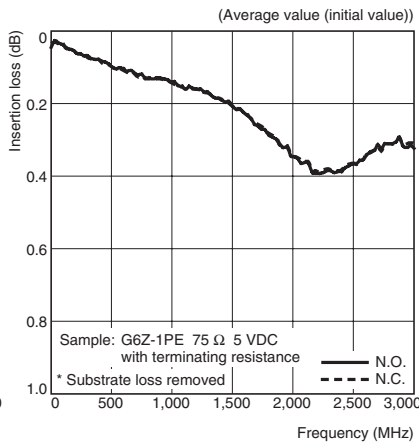

High-frequency Characteristics at 75 Ω (Return Loss, V.SWR)

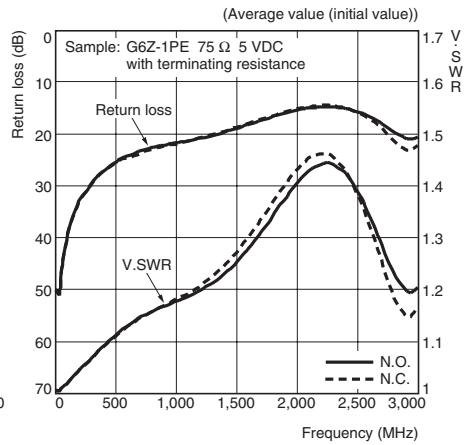

High-frequency Characteristics at 50 Ω (Isolation)

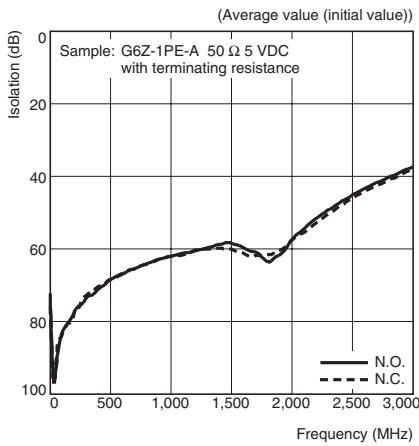

High-frequency Characteristics at 50 Ω (Insertion Loss)

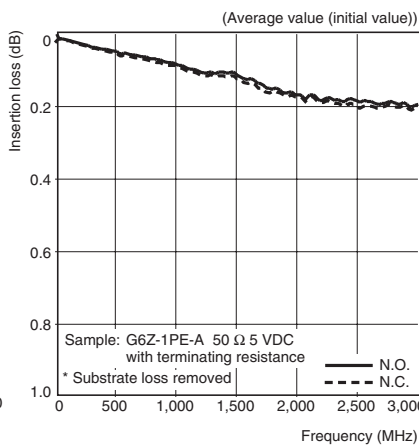

High-frequency Characteristics at 50 Ω (Return Loss, V.SWR)

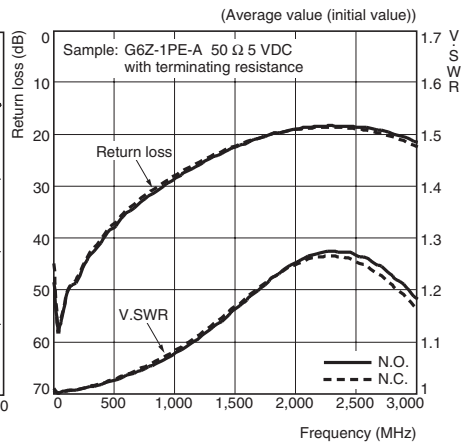

Must Operate and Must Release Time Distribution (See note.)

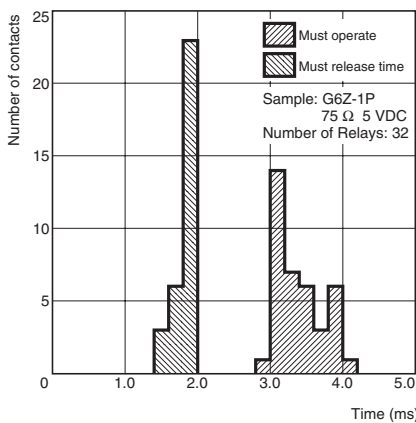

Must Operate and Must Release Bounce Time Distribution (See note.)

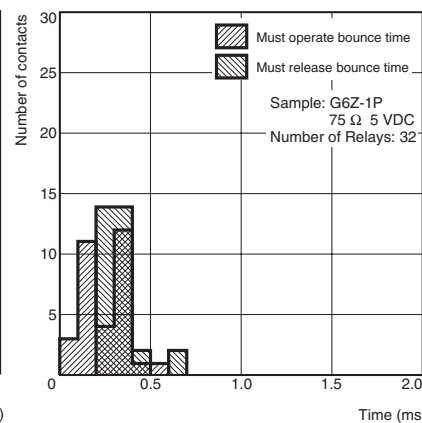

Note: The tests were conducted at an ambient temperature of 23°C.

Dimensions

Unit: mm

PCB Through-hole Terminal Types

G6Z-1PE
G6Z-1PE-R
G6ZU-1PE

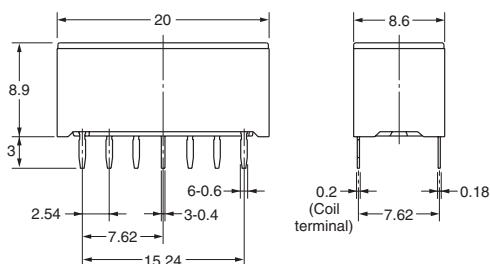
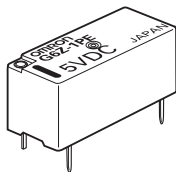

Mounting Dimensions (Bottom View)
Tolerance: ± 0.1 mm

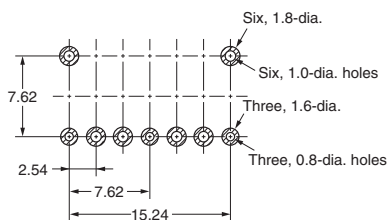

Terminal Arrangement/Internal Connections (Bottom View)

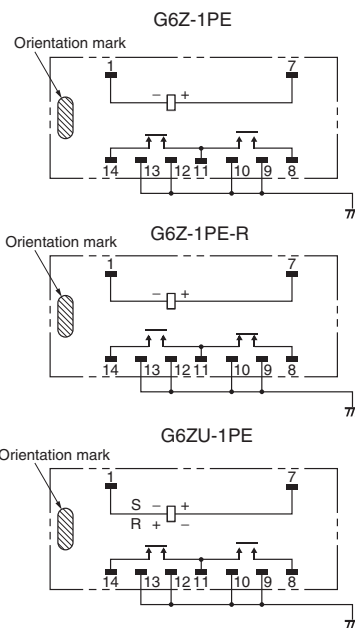

Note: Each value has a tolerance of ± 0.3 mm.

G6Z-1PE-A
G6ZU-1PE-A

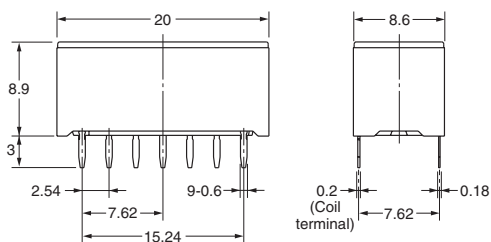
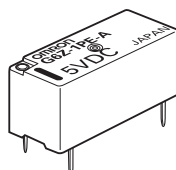

Mounting Dimensions (Bottom View)
Tolerance: ± 0.1 mm

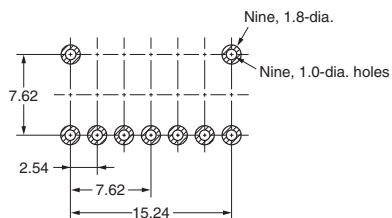

Terminal Arrangement/Internal Connections (Bottom View)

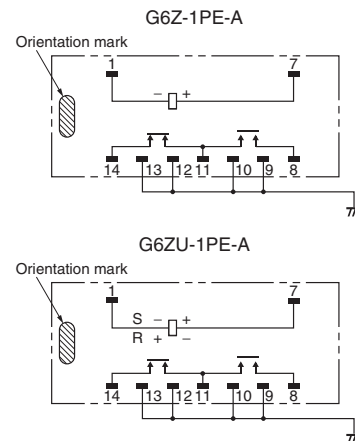

Note: Each value has a tolerance of ± 0.3 mm.

**G6Z-1P
G6ZU-1P**

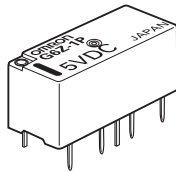

Mounting Dimensions (Bottom View)
Tolerance: ± 0.1 mm

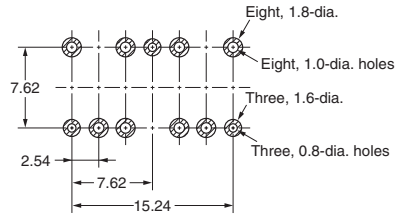

Terminal Arrangement/Internal Connections (Bottom View)

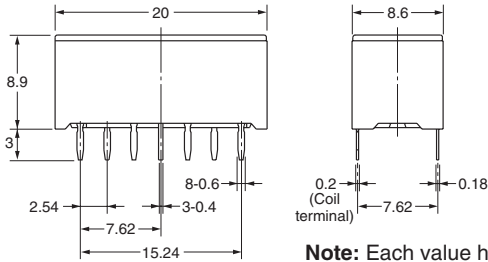
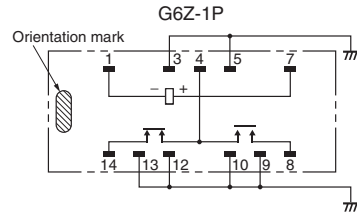

Note: Each value has a tolerance of ± 0.3 mm.

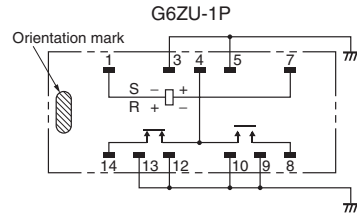

**G6Z-1P-A
G6ZU-1P-A**

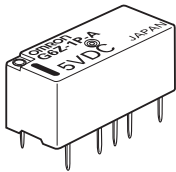

Mounting Dimensions (Bottom View)
Tolerance: ± 0.1 mm

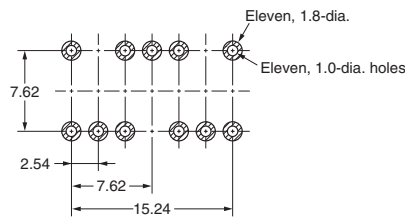

Terminal Arrangement/Internal Connections (Bottom View)

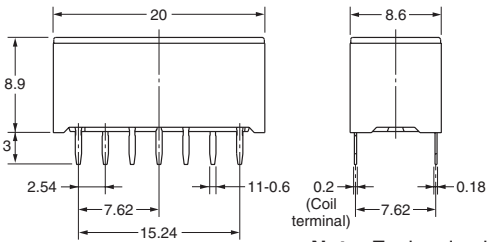
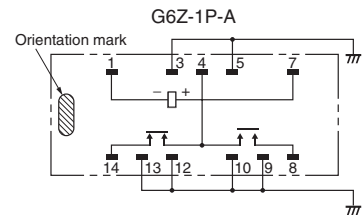

Note: Each value has a tolerance of ± 0.3 mm.

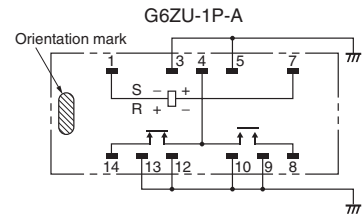

G6ZK-1PE

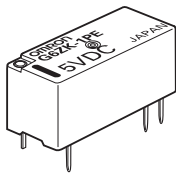

Mounting Dimensions (Bottom View)
Tolerance: ± 0.1 mm

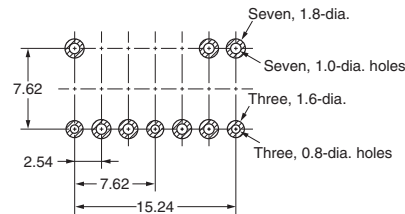

Terminal Arrangement/Internal Connections (Bottom View)

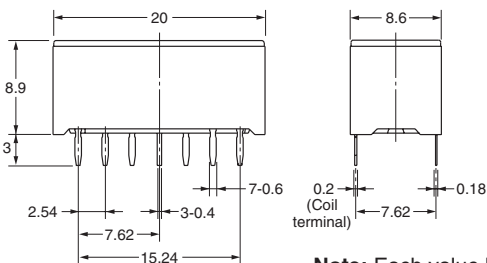
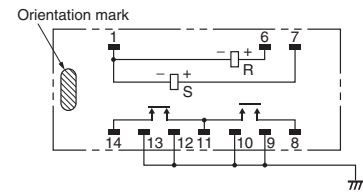

Note: Each value has a tolerance of ± 0.3 mm.

G6ZK-1PE-A

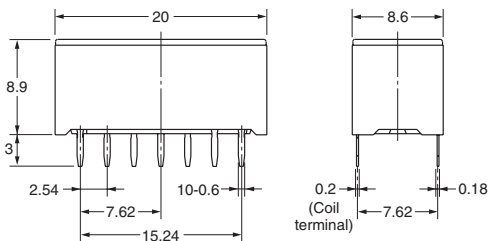
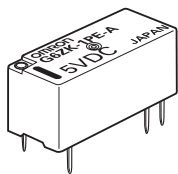

Mounting Dimensions (Bottom View)

Tolerance: ± 0.1 mm

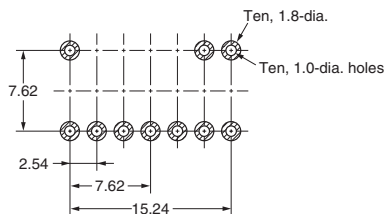

Terminal Arrangement/Internal Connections (Bottom View)

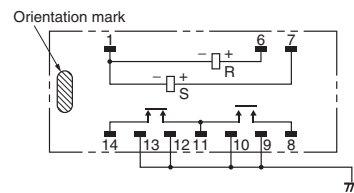

Note: Each value has a tolerance of ± 0.3 mm.

G6ZK-1P

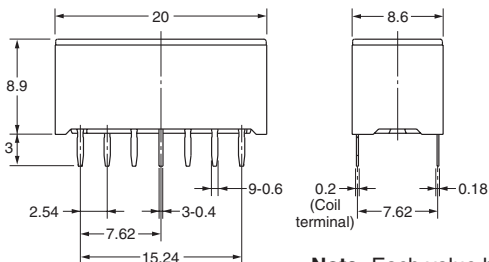
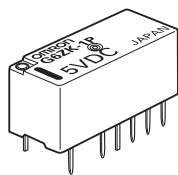

Mounting Dimensions (Bottom View)

Tolerance: ± 0.1 mm

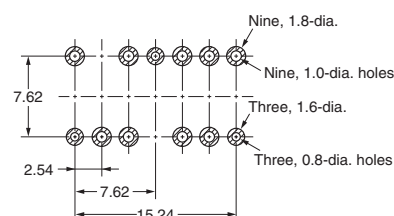

Terminal Arrangement/Internal Connections (Bottom View)

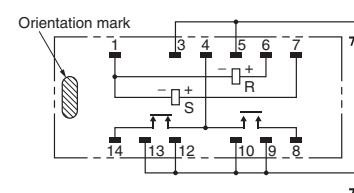

Note: Each value has a tolerance of ± 0.3 mm.

G6ZK-1P-A

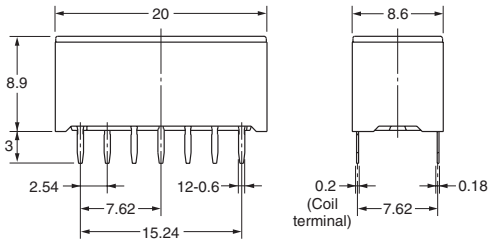
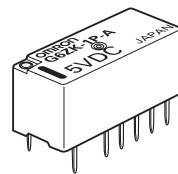

Mounting Dimensions (Bottom View)

Tolerance: ± 0.1 mm

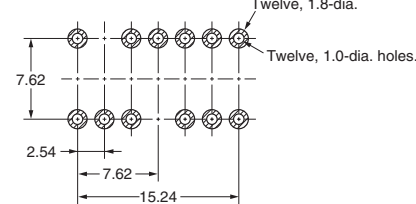

Terminal Arrangement/Internal Connections (Bottom View)

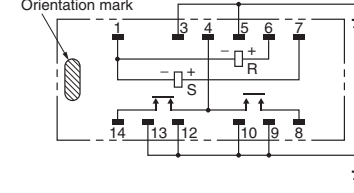

Note: Each value has a tolerance of ± 0.3 mm.

■ Surface Mount Terminal Types

G6Z-1FE
G6ZU-1FE

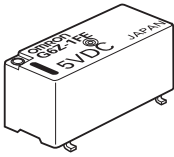

Mounting Dimensions (Top View)
Tolerance: ± 0.1 mm

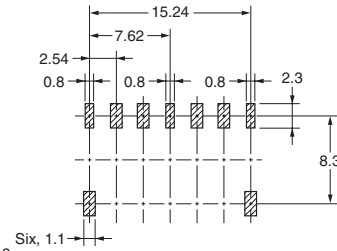
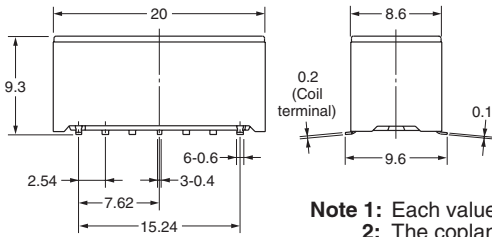

Note 1: Each value has a tolerance of ± 0.3 mm.
Note 2: The coplanarity of the terminals is 0.1 mm max.

Terminal Arrangement/Internal Connections (Top View)

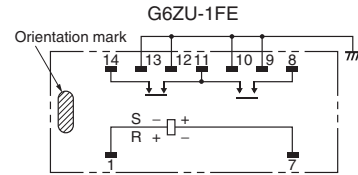
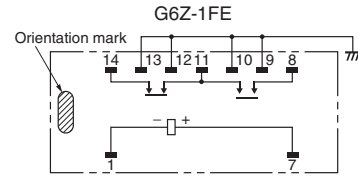

G6Z-1FE-A
G6ZU-1FE-A

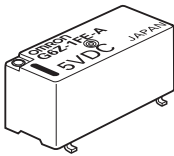

Mounting Dimensions (Top View)
Tolerance: ± 0.1 mm

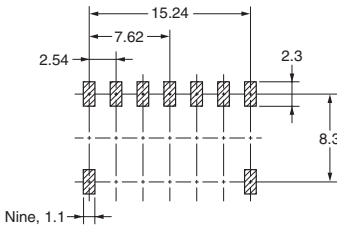
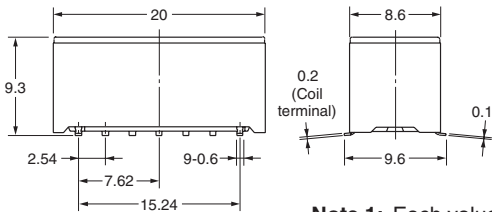

Note 1: Each value has a tolerance of ± 0.3 mm.
Note 2: The coplanarity of the terminals is 0.1 mm max.

Terminal Arrangement/Internal Connections (Top View)

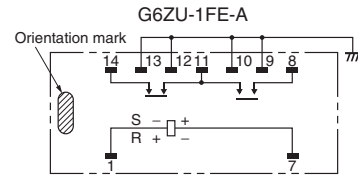
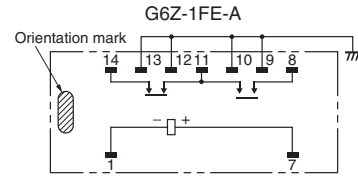

G6Z-1F
G6ZU-1F

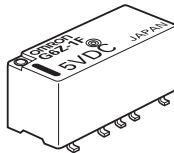

Mounting Dimensions (Top View)
Tolerance: ± 0.1 mm

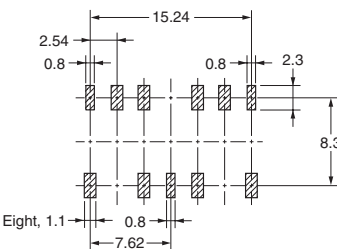
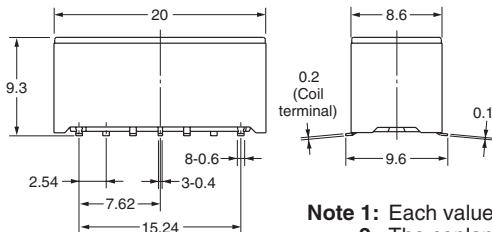

Note 1: Each value has a tolerance of ± 0.3 mm.
Note 2: The coplanarity of the terminals is 0.1 mm max.

Terminal Arrangement/Internal Connections (Top View)

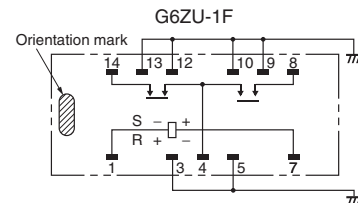
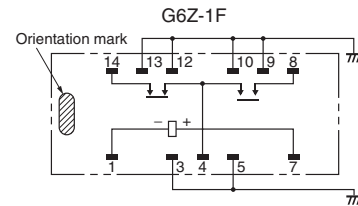

**G6Z-1F-A
G6ZU-1F-A**

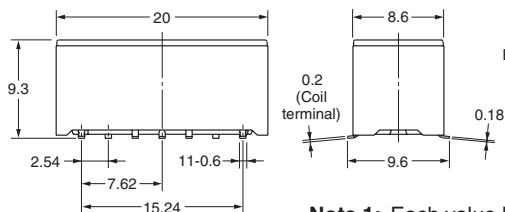
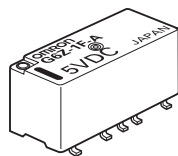

Mounting Dimensions (Top View)
Tolerance: ± 0.1 mm

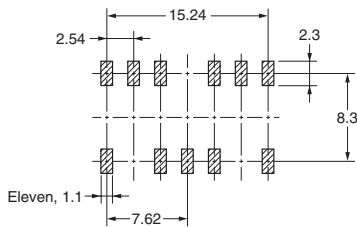

Note 1: Each value has a tolerance of ± 0.3 mm.
Note 2: The coplanarity of the terminals is 0.1 mm max.

Terminal Arrangement/Internal Connections (Top View)

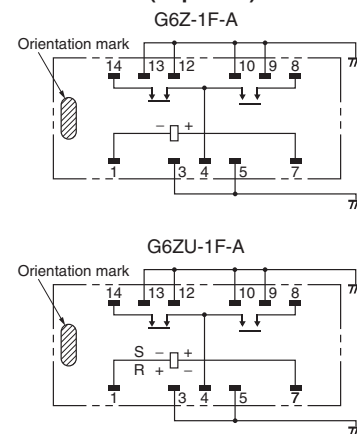

G6ZK-1FE

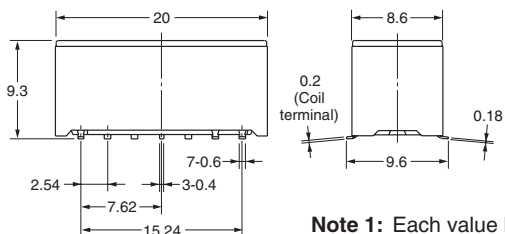
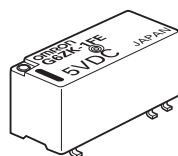

Mounting Dimensions (Top View)
Tolerance: ± 0.1 mm

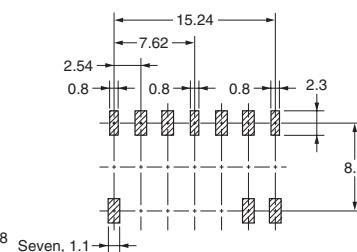

Note 1: Each value has a tolerance of ± 0.3 mm.
Note 2: The coplanarity of the terminals is 0.1 mm max.

Terminal Arrangement/Internal Connections (Top View)

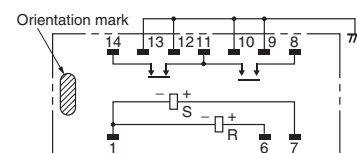

G6ZK-1FE-A

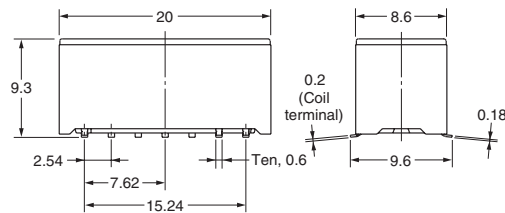
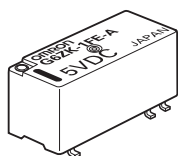

Mounting Dimensions (Top View)
Tolerance: ± 0.1 mm

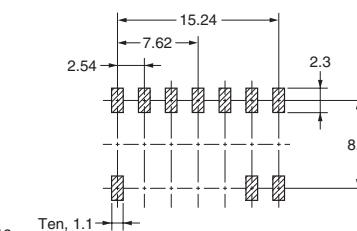

Note 1: Each value has a tolerance of ± 0.3 mm.
Note 2: The coplanarity of the terminals is 0.1 mm max.

Terminal Arrangement/Internal Connections (Top View)

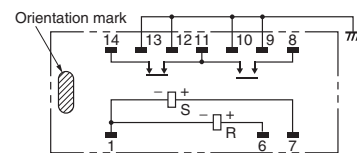

G6ZK-1F

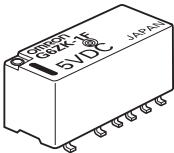

Mounting Dimensions (Top View)

Tolerance: ± 0.1 mm

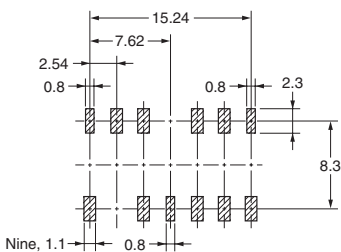
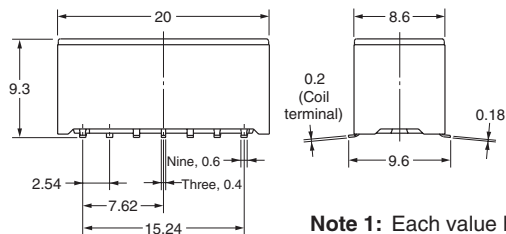

Terminal Arrangement/Internal Connections (Top View)

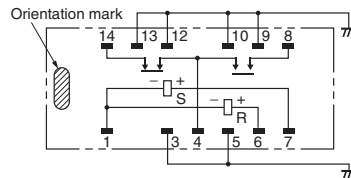

- Note 1:** Each value has a tolerance of ± 0.3 mm.
- Note 2:** The coplanarity of the terminals is 0.1 mm max.

G6ZK-1F-A

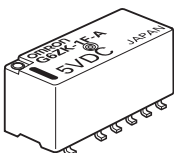

Mounting Dimensions (Top View)

Tolerance: ± 0.1 mm

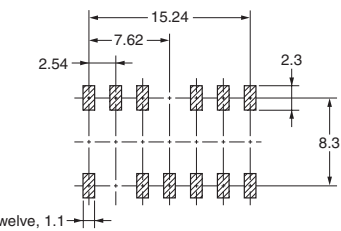
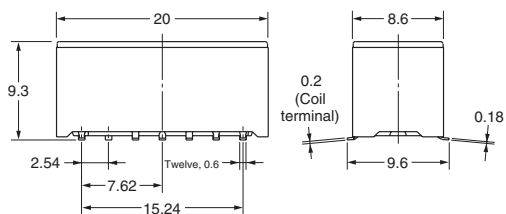

Terminal Arrangement/Internal Connections (Top View)

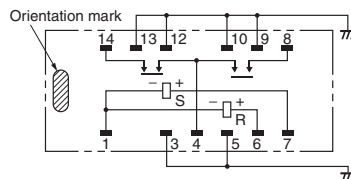

- Note 1:** Each value has a tolerance of ± 0.3 mm.
- Note 2:** The coplanarity of the terminals is 0.1 mm max.

Tube Packaging and Tape and Reel Packaging

■ Tube Packaging

Relays in tube packaging are arranged so that the orientation mark of each Relay is on the left side.

Be sure not to make mistakes in Relay orientation when mounting the Relay to the PCB.

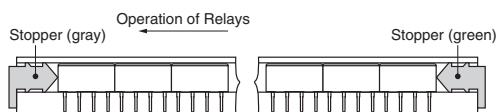

Tube length: 530 mm (stopper not included)
No. of Relays per tube: 25

■ Tape and Reel Packaging (Surface mount Terminal Models)

When ordering Relays in tape packing, add the prefix “-TR” to the model number, otherwise the Relays in stick packing will be provided.

Relays per Reel: 300

Direction of Relay Insertion

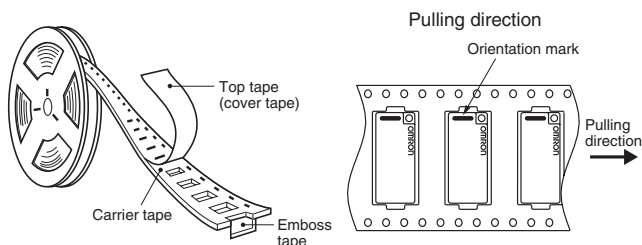

Reel Dimensions

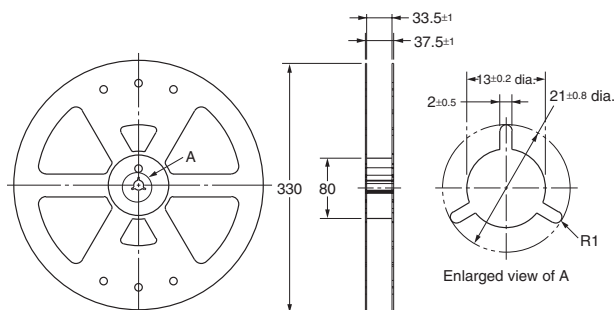

Carrier Tape Dimensions

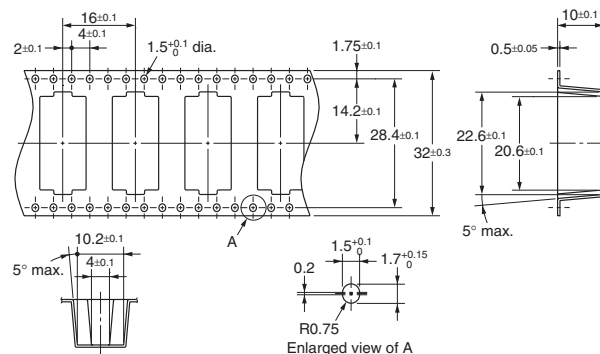

Note: The radius of the unmarked corner is 0.3 mm.

Recommended Soldering Method

Temperature Conditions for IRS Method

When using reflow soldering, ensure that the Relay terminals and the top of the case stay below the following curve. Check that these conditions are actually satisfied before soldering the terminals.

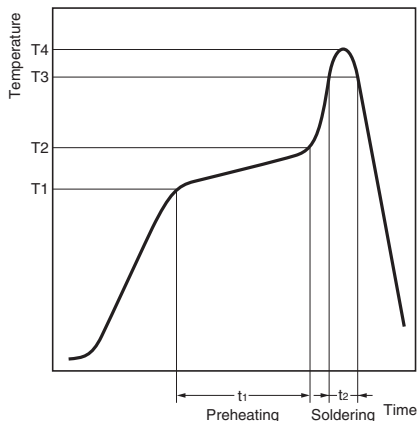

| Measured part | Preheating (T1 → T2, t1) | Soldering (T3, t2) | Maximum peak (T4) |
|---------------|--------------------------|----------------------|-------------------|
| Terminals | 150 → 180°C, 120 s max. | 230°C min, 30 s max. | 250°C max. |
| Top of case | --- | --- | 255°C max. |

Do not quench the terminals after mounting. Clean the Relay using alcohol or water no hotter than 40°C max.

The thickness of cream solder to be applied should be between 150 and 200 μm on OMRON's recommended PCB pattern.

Correct Soldering

Incorrect Soldering

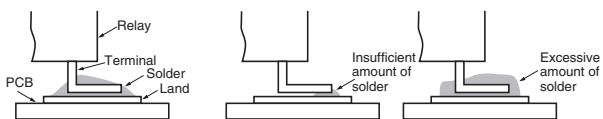

Check the soldering in the actual mounting conditions before use.

Safety Precautions

■ Precautions for Correct Use

Please observe the following precautions to prevent failure to operate, malfunction, or undesirable effect on product performance.

High-frequency Characteristics Measurement Method and Measurement Substrate

High-frequency characteristics for the G6Z are measured in the way shown below. Consult your OMRON representative for details on 50-Ω models.

Measurement Method for 75-Ω Models

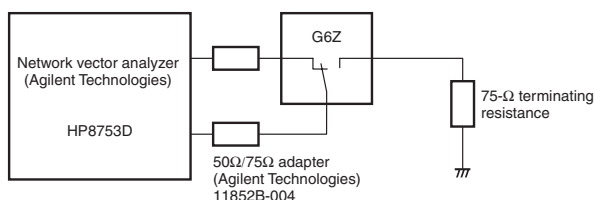

Through-hole Substrate (75-Ω Models, E-shape or Y-shape)

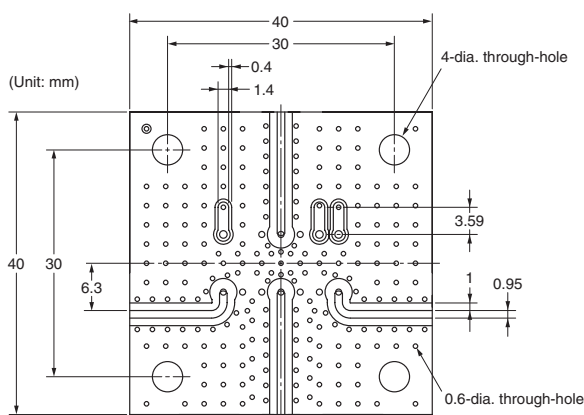

SMD-type Substrate (75-Ω Models, E-shape or Y-shape)

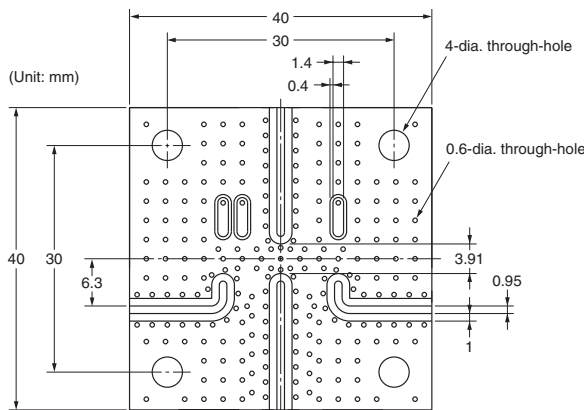

Substrate for High-frequency Characteristic Compensation (75-Ω Models, E-shape or Y-shape)

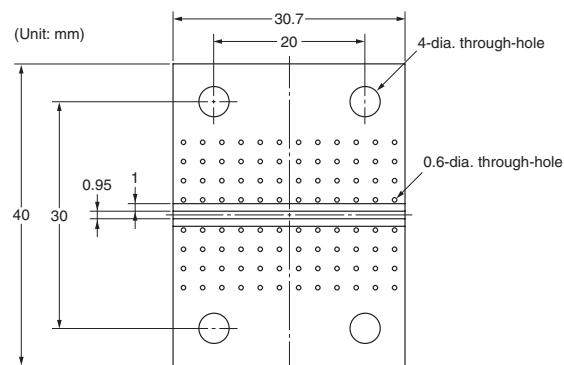

Substrate Types

Material: FR-4 glass epoxy (glass cloth impregnated with epoxy resin and copper laminated to its outer surface)

Thickness: 1.6 mm

Thickness of copper plating: 18 μm

- Note:**
1. The compensation substrate is used when measuring the Relay's insertion loss. The insertion loss is obtained by subtracting the measured value for the compensation substrate from the measured value with the Relay mounted to the high-frequency measurement substrate.
 2. For convenience, the diagrams of the high-frequency measurement substrates given here apply both to models with an E-shape terminal structure and to models with a Y-shape terminal structure.
 3. Be sure to mount a standoff tightly to the through-hole substrate.
 4. Use measuring devices, connectors, and substrates that are appropriate for 50 Ω and 75 Ω respectively.
 5. Ensure that there is no pattern under the Relay. Otherwise, the impedance may be adversely affected and the Relay may not be able to attain its full characteristics.

Handling

Do not use the Relay if it has been dropped. Dropping the Relay may adversely affect its functionality.

Protect the Relay from direct sunlight and keep the Relay under normal temperature, humidity, and pressure.

Flow Soldering

Solder: JIS Z3282, H63A

Soldering temperature: Approx. 250°C (260°C if the DWS method is used)

Soldering time: Approx. 5 s max. (approx. 2 s for the first time and approx. 3 s for the second time if the DWS method is used)

Be sure to make a molten solder level adjustment so that the solder will not overflow on the PCB.

Claw Securing Force During Automatic Mounting

During automatic insertion of Relays, be sure to set the securing force of each claw to the following so that the Relay's characteristics will be maintained.

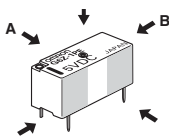

Direction A: 4.90 N max.
 Direction B: 4.90 N max.
 Direction C: 4.90 N max.

Secure the claws to the shaded area.
 Do not attach them to the center area
 or to only part of the Relay.

Latching Relay Mounting

Make sure that the vibration or shock that is generated from other devices, such as Relays, on the same panel or substrate and imposed on the Latching Relay does not exceed the rated value, otherwise the set/reset status of the Latching Relay may be changed. The Latching Relay is reset before shipping. If excessive vibration or shock is imposed, however, the Latching Relay may be set accidentally. Be sure to apply a reset signal before use.

Coating

Do not use silicone coating to coat the Relay when it is mounted to the PCB. Do not wash the PCB after the Relay is mounted using detergent containing silicone. Otherwise, the detergent may remain on the surface of the Relay.

ALL DIMENSIONS SHOWN ARE IN MILLIMETERS. To convert millimeters into inches, divide by 25.4



OMRON ELECTRONICS LLC
 One Commerce Drive
 Schaumburg, IL 60173
847-882-2288

OMRON CANADA, INC.
 885 Milner Avenue
 Toronto, Ontario M1B 5V8
416-286-6465

OMRON ON-LINE
 Global - <http://www.omron.com>
 USA - <http://www.omron.com/oei>
 Canada - <http://www.omron.ca>