

Features

1. Normally Open, Single Pole Single Throw
2. Control 400VAC or DC Voltage
3. Switch 130mA Loads
4. LED control Current, 5mA
5. Low ON-Resistance
6. dv/dt, >500V/ms
7. Isolation Test Voltage, 3750VACrms

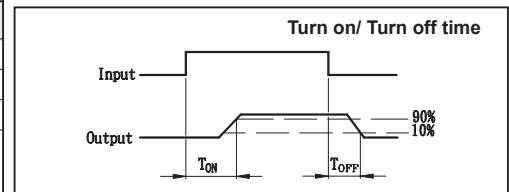
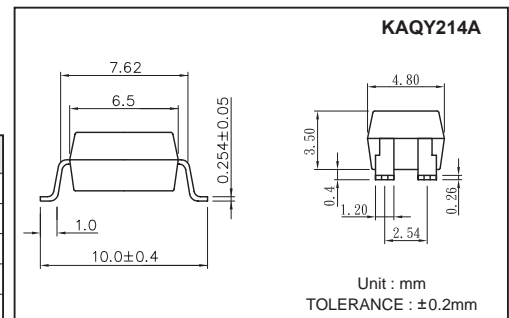
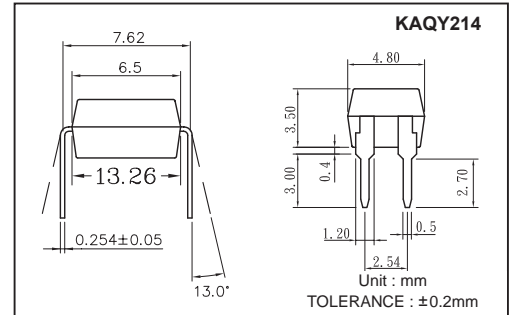

Absolute Maximum Ratings

(Ta=25°C)

Emitter (Input)	Detector (Output)
Reverse Voltage.....5.0V	Output Breakdown Voltage±400V
Continuous Forward Current50mA	Continuous Load Current±130mA
Peak Forward Current1A	Power Dissipation500mW
Power Dissipation100mW	
Derate Linearly from 25°C1.3mW/°C	
General Characteristics	
Isolation Test Voltage3750VACrms	Storage Temperature Range ...-40°C to +125°C
Isolation Resistance	Operating Temperature Range...-30°C to +85°C
Vio=500V, Ta=25°C≥10 ¹⁰ Ω	Junction Temperature.....100°C
Total Power Dissipation550mW	Soldering Temperature,
Derate Linearly from 25°C2.5mW/°C	2mm from case, 10 sec260°C

Electro-optical Characteristics

(Ta=25°C)

Parameter	Symbol	Conditions	Min.	Typ.	Max.	Unit
Emitter (Input)						
Forward Voltage	V _F	I _F =10mA		1.2	1.5	V
Operation Input Current	I _{FOFF}	V _L =±20V, I _L ≤5uA			5	mA
Recovery Input Current	I _{FON}	V _L =±20V, I _L =100mA, t =10mS	0.2			mA
Detector (Output)						
Output Breakdown Voltage	V _B	I _B =50uA	400			V
Output Off-State Leakage	I _{TOFF}	V _T =100V, I _F =0mA		0.2	1	uA
I/O Capacitance	C _{ISO}	I _F =0, f =1MHz		6		pF
ON Resistance	R _{ON}	I _L =100mA, I _F =10mA		20	30	Ω
Turn-On Time	T _{ON}	I _F =10mA, V _L =±20V		0.3	1.0	ms
Turn-Off Time	T _{OFF}	t =10ms, I _L =±100mA		0.7	1.5	ms

Mos Relay Schematic and Wiring Diagrams

Type	Schematic	Output configuration	Load	Connection	Wiring Diagrams
KAQY214 & KAQY214A		1a	AC/DC	-	

Data Curve

