

### Features

1. Current transfer ratio  
(CTR:MIN.60% at  $I_F = \pm 1\text{mA}$ ,  $V_{ce} = 5\text{V}$ )
2. High isolation voltage between input and output  
(Viso:5000Vrms).
3. Compact dual-in-line package.
4. Ac input.
5. Available package : DIP/ SMD/ H. (For Package Dimension please refer to page 82 )

### Applications

1. Programmable Controller Applications for Low Input Photocouplers and High Vceo Photocouplers.
2. Telephone sets, telephone exchangers.
3. System appliances, Limit Switches, Sensors, Thermostats and Transducers etc.
4. Signal transmission between circuits of different potentials and impedances.

### Outside Dimension : Unit (mm)

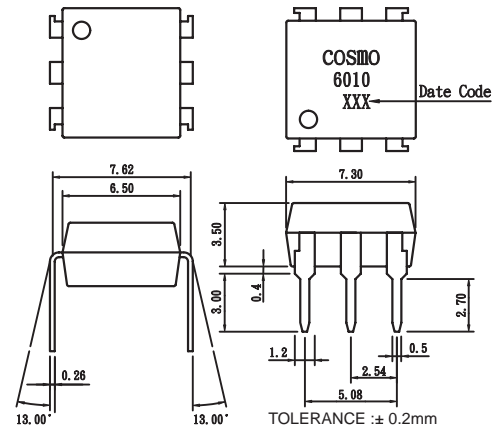

### Schematic : Top View

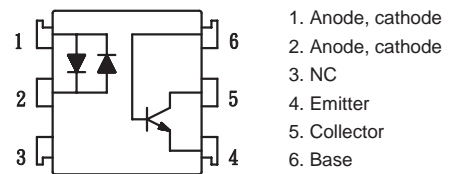

### Absolute Maximum Ratings

( $T_a = 25^\circ\text{C}$ )

Parameter		Symbol	Rating	Unit
Input	Forward current	$I_F$	$\pm 50$	mA
	Peak forward current	$I_{FM}$	$\pm 1$	A
	Power dissipation	$P_D$	70	mW
Output	Collector-emitter voltage	$V_{CEO}$	60	V
	Emitter-collector voltage	$V_{ECO}$	6	V
	Collector-base voltage	$V_{CBO}$	60	V
	Emitter-base voltage	$V_{EBO}$	6	V
	Collector current	$I_C$	50	mA
	Collector power dissipation	$P_C$	150	mW
Total power dissipation		$P_{tot}$	200	mW
Isolation voltage 1 minute		Viso	5000	Vrms
Operating temperature		$T_{opr}$	-30 to +100	$^\circ\text{C}$
Storage temperature		$T_{stg}$	-55 to +125	$^\circ\text{C}$
Soldering temperature 10 second		$T_{sol}$	260	$^\circ\text{C}$

### Electro-optical Characteristics

( $T_a = 25^\circ\text{C}$ )

Parameter		Symbol	Conditions	MIN.	TYP.	MAX.	Unit
Input	Forward voltage	$V_F$	$I_F = \pm 20\text{mA}$	—	1.2	1.4	V
	Peak forward voltage	$V_{FM}$	$I_{FM} = \pm 0.5\text{A}$	—	—	3.5	V
	Terminal capacitance	$C_t$	$V = 0, f = 1\text{kHz}$	—	30	—	pF
Output	Collector dark current	$I_{CEO}$	$V_{CE} = 20\text{V}, I_F = 0$	—	—	0.1	$\mu\text{A}$
Transfer characteristics	Current transfer ratio	CTR	$I_F = \pm 1\text{mA}, V_{CE} = 5\text{V}$	60	—	600	%
	Collector-emitter saturation voltage	$V_{CE}(\text{sat})$	$I_F = \pm 20\text{mA}, I_C = 1\text{mA}$	—	0.1	0.3	V
	Isolation resistance	Riso	DC500V	$5 \times 10^{10}$	$10^{11}$	—	ohm
	Floating capacitance	$C_f$	$V = 0, f = 1\text{MHz}$	—	0.6	1.0	pF
	Cut-off frequency	$f_c$	$V_{CC} = 5\text{V}, I_C = 2\text{mA}, R_L = 100\text{ohm}$	—	80	—	kHz
	Response time (Rise)	$t_r$	$V_{CE} = 2\text{V}, I_C = 2\text{mA}, R_L = 100\text{ohm}$	—	5	20	$\mu\text{s}$
	Response time (Fall)	$t_f$		—	4	20	$\mu\text{s}$

Classification table of current transfer ratio is shown below.

Model NO.	Rank mark	CTR (%)
KP6010	A	60 TO 600
KP6010	B	60 TO 300

**Fig.1** Current Transfer Ratio vs. Forward Current

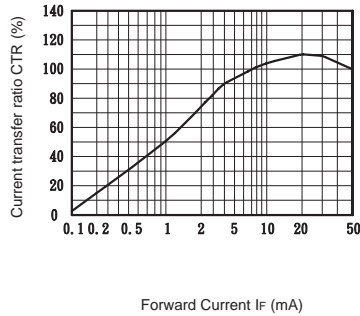

**Fig.2** Collector Power Dissipation vs. Ambient Temperature

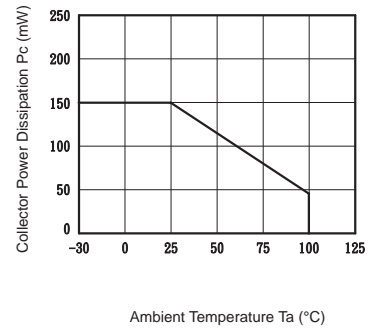

**Fig.3** Collector Dark Current vs. Ambient Temperature

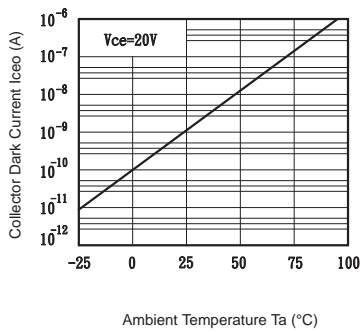

**Fig.4** Forward Current vs. Ambient Temperature

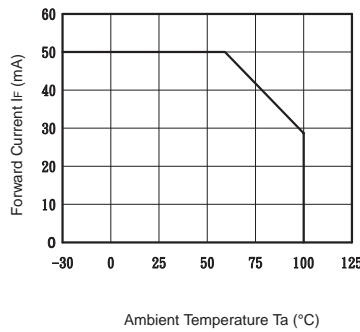

**Fig.5** Forward Current vs. Forward Voltage

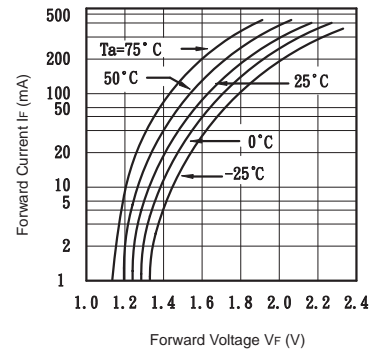

**Fig.6** Collector Current vs. Collector-emitter Voltage

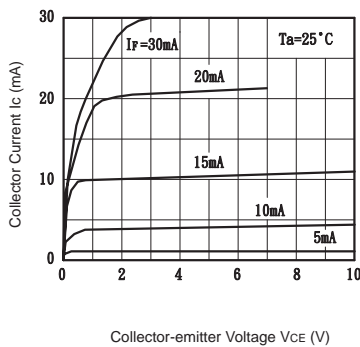

**Fig.7** Relative Current Transfer Ratio vs. Ambient Temperature

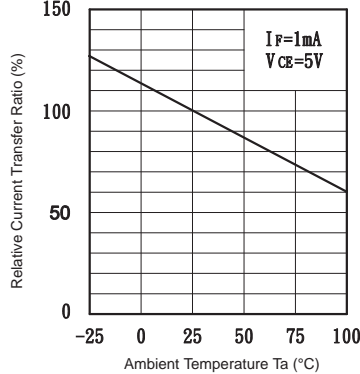

**Fig.8** Collector-emitter Saturation Voltage vs. Ambient Temperature

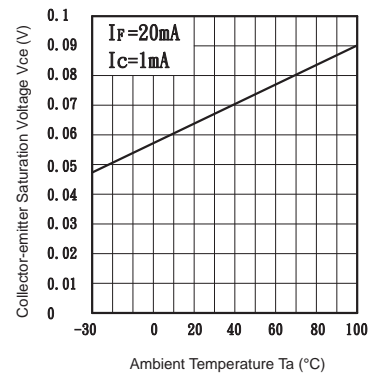

**Fig.9** Collector-emitter Saturation Voltage vs. Forward Current

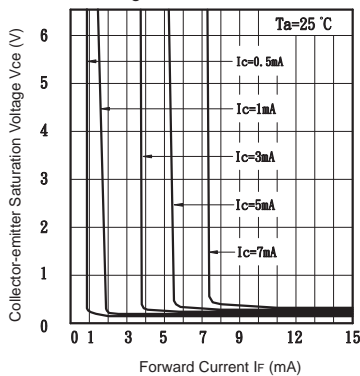

**Fig.10** Response Time vs. Load Resistance

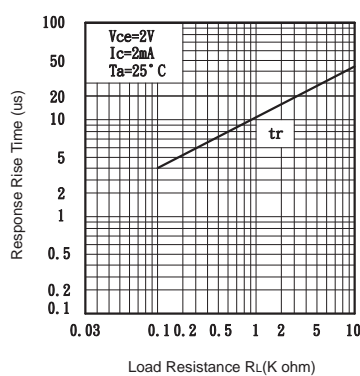

**Fig.11** Response Time vs. Load Resistance

