

The Best Relaytion

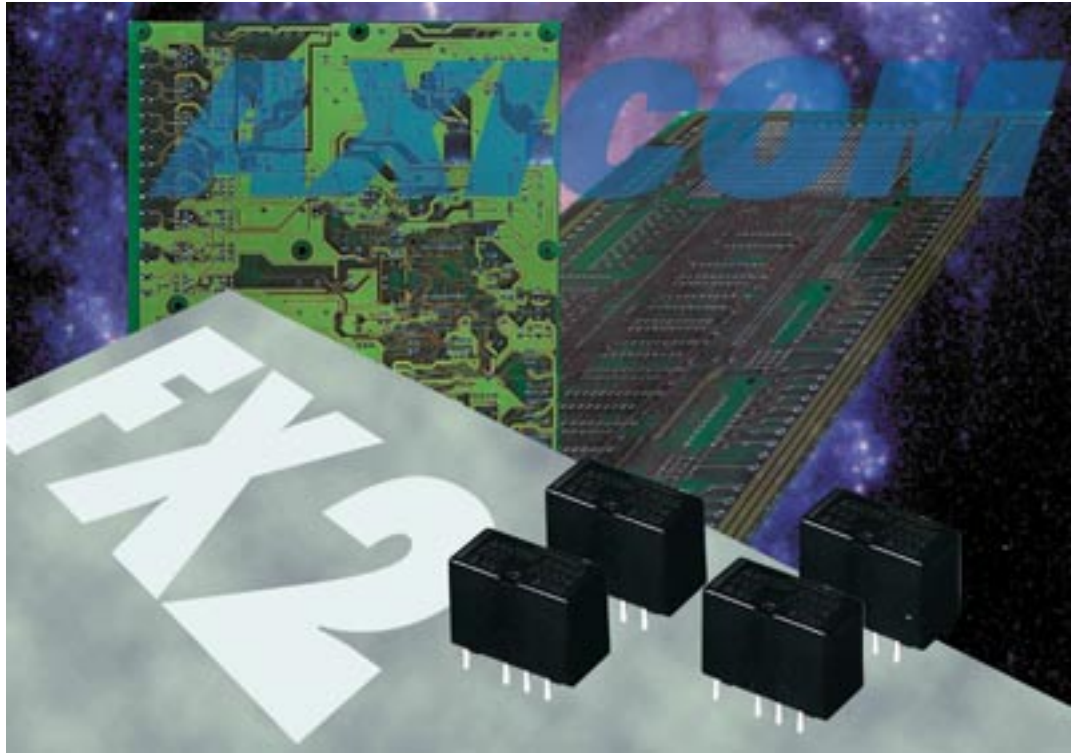

FX2 Relay



108-98003
Rev. C
EC-JM00-0009-03
ECOC: JM10
1. Apr 04

2 pole telecom / signal relay
Through Hole Type (THT)
Polarized, latching or non-latching 1 coil

Versions

- Relay types: sensitive non latching version with 1 coil
high sensitive non latching version with 1 coil
latching with 1 coil

Features

- Telecom / signal relay (dry circuit, test access, ringing)
- Slim line 15 x 7.3 mm, 0.590 x 0.287 inch
- Switching current 2 A
- 2 changeover contacts (2 form C / DPDT)
- Bifurcated contacts
- High sensitivity results in low nominal power consumption
80 mW for high sensitive, 140 mW for sensitive version
- High dielectric characteristic
≥ 1800 Vrms also between open contact
- High surge capability (1.2 / 50 μs and 10 / 700 μs) meets
Bellcore GR 1089 and FCC Part 68
≥ 2500 V between open contacts
≥ 3500 V between coil and contacts
- High mechanical shock
up to 300 G functional
up to 1500 G survival

Typical applications

- Communications equipment
linecard application - analog, ISDN, xDSL, PABX
Voice over IP
- Office and business equipment
- Measurement and control equipment
- Consumer electronics
Set top boxes, HiFi
- Medical equipment



UL 508 File No. E111441
UL 60950



IEC 61811-54002
(QC 160504)

IEC/EN60950 IEC Ref. Cert. No. 2169

Insulation category:

Supplementary insulation according IEC / EN 60950
Working voltage ≥ 300 Vrms
Mains supply voltage ≥ 250 Vrms
Repetitive peak voltage 2500 V
Pollution degree: Internal: 1
External: 2
Flammability classification: V-0
Maximum operating temperature: 85 °C

European Directive conformance:

FX2 relay product conformance according to:

- Directive 2000/53/EC: ELV (End of Life of Vehicles)
- Directive 2002/95/EC: ROHS (Restrictions of the use of certain hazardous substances in electrical and electronic equipment)

Compliance is evidenced by written declaration from all raw material suppliers.
Tyco Electronics AXICOM only has responsibility for the proper processing of these materials.
Confirmation is valid for date codes ≥ 0342

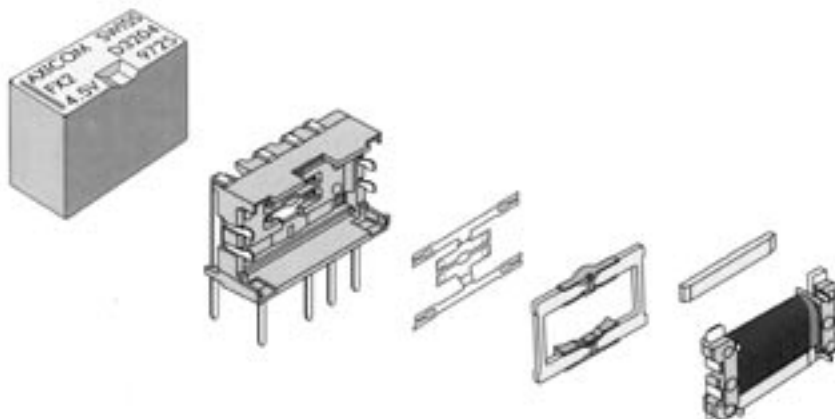

Dimensions

	THT	
	mm	inch
L	14.93 ± 0.08	0.587 ± 0.003
W	7.27 ± 0.08	0.283 ± 0.003
H	10.7 ± 0.08	0.421 ± 0.003
T	3.3 ± 0.3	0.129 ± 0.011
T1	N/A	N/A
T2	5.08 ± 0.1	0.200 ± 0.004
Tw	0.5	0.020
S	0.3 ± 0.05	0.011 ± 0.002

THT Version

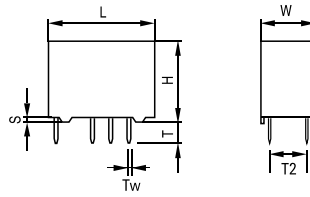

Mounting hole layout

View onto the component side of the PCB
(top view)

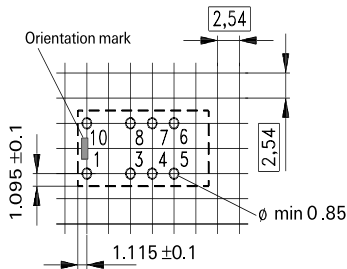

Basic grid 2.54 mm

Terminal assignment

Relay - top view

Non-latching type,
not energized condition

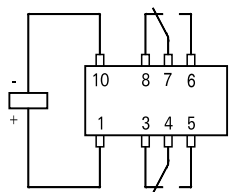

Latching type, 1 coil
reset condition

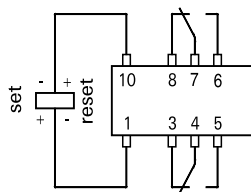

Coil Data (values at 23 °C)				Ordering Information			
Nominal voltage U_{nom}	Operate/set voltage range		Release/reset voltage Minimum	Coil power	Coil Resistance	Relay code	Tyco part number
	Minimum voltage U_{min}	Maximum voltage U_{max}					
Vdc	Vdc	Vdc	Vdc	mW	$\Omega / \pm 10\%$		

non-latching
1 coil

3	2.1	6.3	0.30	140	64	D 3206	0-1462034-6
4	2.8	8.4	0.40	140	114	D 3207	0-1462034-8
4.5	3.15	9.4	0.45	140	145	D 3204	0-1462034-2
5	3.5	10.5	0.50	140	178	D 3209	0-1462034-9
6	4.2	12.6	0.60	140	257	D 3205	0-1462034-5
9	6.3	18.9	0.90	140	574	D 3210	1-1462034-3
12	8.4	25.2	1.20	140	1028	D 3202	0-1462034-1
24	16.8	42.2	2.40	200	2880	D 3212	1-1462034-4
48	33.6	68.9	4.80	300	7680	D 3213	1-1462034-5

non-latching 1 coil
high sensitive version

3	2.25	8.3	0.3	80	113	D 3221	1-1462034-9
4.5	3.38	11.1	0.45	80	253	D 3222	2-1462034-0
5	3.75	12.5	0.5	80	313	D 3223	2-1462034-1
6	4.5	13.9	0.6	80	450	D 3224	2-1462034-2
9	6.75	16.7	0.9	80	1013	D 3225	2-1462034-3
12	9.00	33.4	1.2	80	1800	D 3226	2-1462034-4
24	18.00	50.4	2.4	140	4114	D 3227	2-1462034-5
48	36.00	70.0	4.8	260	8882	D 3228	2-1462034-6

latching
1 coil

3	2.25	7.5	2.25	100	90	D 3241	2-1462034-8
4.5	3.375	11.2	3.375	100	203	D 3242	2-1462034-9
5	3.75	12.4	3.75	100	250	D 3243	3-1462034-0
6	4.5	14.9	4.50	100	360	D 3244	3-1462034-1
9	6.75	22.4	6.75	100	810	D 3245	3-1462034-2
12	9.00	29.8	9.00	100	1440	D 3246	3-1462034-3
24	18.00	48.7	18.00	150	3840	D 3247	3-1462034-4

Further coil versions are available on request.

Coil operating range

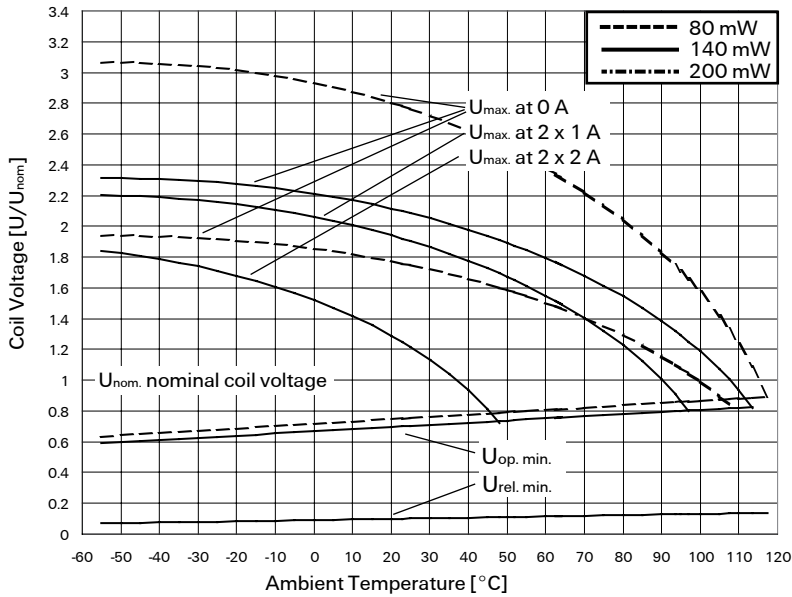

- U_{nom} = Nominal coil voltage
- U_{max.} = Upper limit of the operative range of the coil voltage (limiting voltage) when coils are continuously energized
- U_{op. min.} = Lower limit of the operative range of the coil voltage (reliable operate voltage)
- U_{rel. min.} = Lower limit of the operative range of the coil voltage (reliable release voltage)

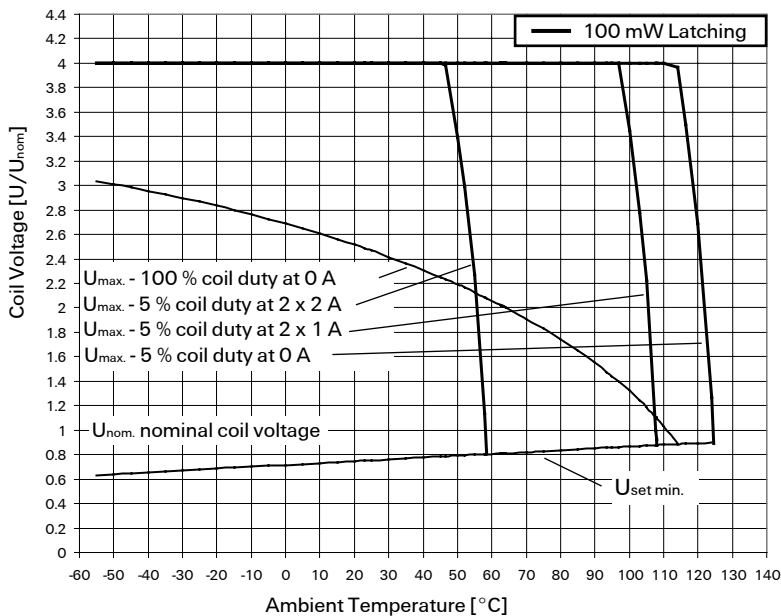
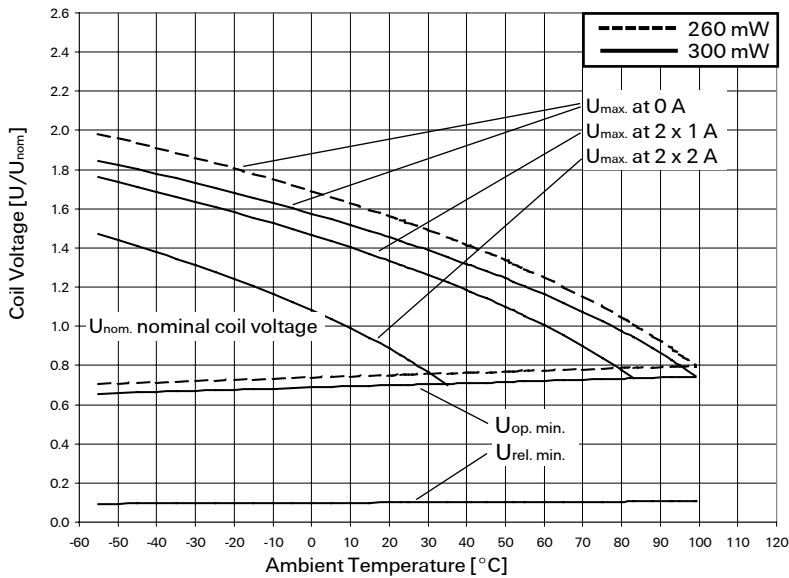

Contact Data	
Number of contacts and type	2 changeover contacts
Contact assembly	Bifurcated contacts
Contact material	Palladium-ruthenium - gold covered
Limiting continuous current at max. ambient temperature	2 A
Maximum switching current	2 A
Maximum swichting voltage	220 Vdc 250 Vac
Maximum switching capacity	60 W, 62.5 VA
Thermoelectric potential	< 10 μ V
Minimum switching voltage	100 μ V
Initial contact resistance / measuring condition: 10 mA / 20 mV	< 70 m Ω
Electrical endurance	at contact application 0 (≥ 30 mV / ≥ 10 mA) at cable load open end at 24 V / 1.25 A at 125 V / 0.24 A at 30 V / 2 A
Mechanical endurance	min. 2.5 x 10 ⁶ operations min. 2.0 x 10 ⁶ operations min. 5 x 10 ⁵ operations min. 5 x 10 ⁵ operations min. 5 x 10 ⁵ operations
UL contact ratings	typ. 10 ⁸ operations 220 Vdc / 0.24 A - 60 W 125 Vdc / 0.24 A - 30 W 250 Vac / 0.25 A - 62.5 VA 125 Vac / 0.5 A - 62.5 VA 30 Vdc / 2 A - 60 W

Max. DC load breaking capacity

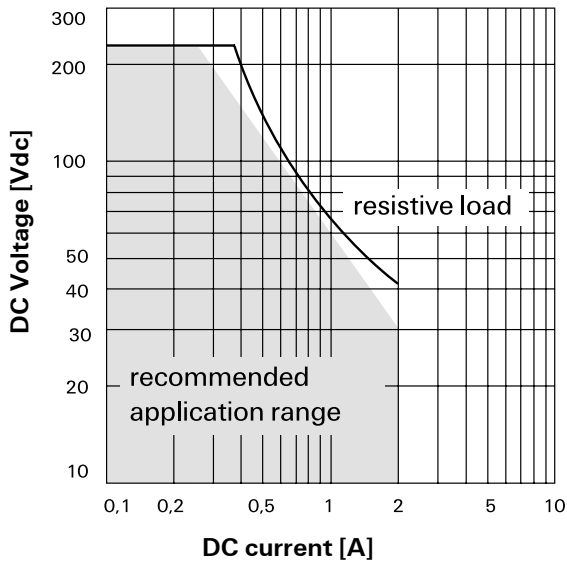

Insulation

Insulation resistance at 500 Vdc	> 10 ⁹ Ω
Dielectric test voltage (1 min)	
between coil and contacts	1800 Vrms
between adjacent contact sets	1800 Vrms
between open contacts	1800 Vrms
Surge voltage resistance	
according to Bellcore GR 1089 (2 / 10 μs)	
between coil and contacts	3500 V
between adjacent contact sets	2500 V
between open contacts	2500 V
according to FCC 68 (10 / 160 μs) and IEC (10 / 700 μs)	
between coil and contacts	3500 V
between adjacent contact sets	2500 V
between open contacts	2500 V

High Frequency Data

Capacitance	
between coil and contacts	max. 4 pF
between adjacent contact sets	max. 2 pF
between open contacts	max. 2 pF
RF Characteristics	
Isolation at 100 MHz / 900 MHz	- 34.0 dB / - 15.1 dB
Insertion loss at 100 MHz / 900 MHz	- 0.03 dB / - 0.60 dB
V.S.W.R. at 100 MHz / 900 MHz	1.07 / 1.45

General data

Operate time at U_{nom} typ. / max.	3 ms / 4 ms
Reset time (latching) at U_{nom} , typ. / max.	3 ms / 4 ms
Release time without diode in parallel (non-latching), typ. / max.	1 ms / 3 ms
Release time with diode in parallel (non-latching), typ. / max.	3 ms / 4 ms
Bounce time at closing contact, typ. / max.	1 ms / 5 ms
Maximum switching rate without load	50 operations/s
Ambient temperature	-55° C ... +85° C
Thermal resistance	< 165 K/W
Maximum permissible coil temperature	125° C
Vibration resistance (function)	20 G
	10 to 500 Hz
Shock resistance, half sinus, 11 ms	50 G (function)
	1500 G (damage)
Degree of protection / Environmental protection	immersion cleanable, IP 67 / RT V
Needle flame test	application time 20 s, no burning
Mounting position	any
Processing information	Ultrasonic cleaning is not recommended
Weight (mass)	max. 2.5 g
Terminal surface	SnCu 0.7
Resistance to soldering heat	260° C / 10 s

All data refers to 23° C unless otherwise specified.

Packing
Stick dimension

Tube for THT version - 50 relays per stick, 1000 relays per box

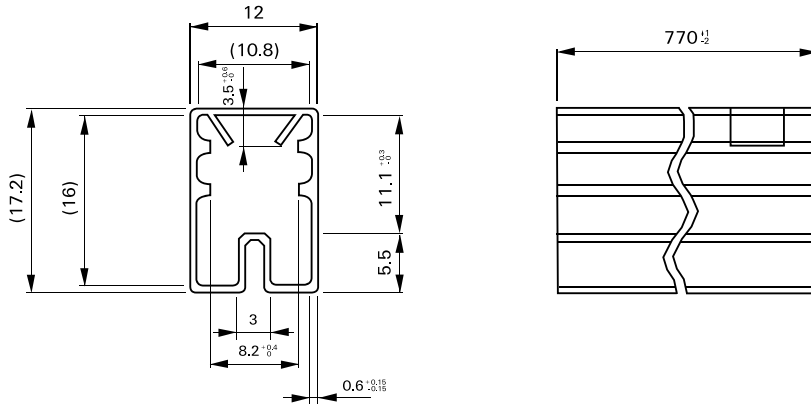

IM Relays

4th generation slim line – low profile polarized 2 c/o telecom relay with bifurcated contacts, available as non latching or latching relay with 1 coil. Nominal voltage range from 1.5... 24 V, coil power consumption of 140... 200 mW, latching relays with 1 coil 100 mW. The IM relay is available as through hole and surface mount type (J-Legs and Gull Wings) and capable to switch loads up to 60 W/62,5 VA. Dielectric strength fulfills the Bellcore requirements according GR 1089 (2,5 kV – 2 / 10 μ s) and FCC part 68 (1,5 kV – 10 / 160 μ s). The IM relay is CECC/IECQ approved and certified in accordance with IEC/EN 60950 and UL 1950. Dimensions approx. 10 x 6 mm board space and 5,65 mm height.

P2 Relays

3rd generation polarized 2 c/o telecom relay with bifurcated contacts, available as non latching or latching relay with 1 or 2 coils. Nominal voltage range from 3 ... 24 V, coil power consumption 140 mW, latching relays with 1 coil 70 mW. The P2 Relay is available as through hole or surface mount type and capable to switch currents up to 5 A. Dielectric strength fulfills the Bellcore requirements according GR 1089 (2,5 kV – 2 / 10 μ s) and FCC part 68 (1,5 kV – 10 / 160 μ s). Dimensions approx. 15 x 7,5 mm board space and 10 mm height.

FX Relays

3rd generation polarized 2 c/o telecom relay with bifurcated contacts, available as non latching or latching relay with 1 coil. Nominal voltage range from 3 ... 48 V, coil power consumption of 80 ... 260 mW for the high sensitive version, 140... 300 mW for the standard version, latching relays with 1 coil 100 mW. The FX2 relay is available as through hole type and capable to switch loads up to 60 W/62,5 VA. Dielectric strength fulfills the Bellcore requirements according GR 1089 (2,5 kV – 2 / 10 μ s) and FCC part 68 (1,5 kV – 10 / 160 μ s). The FX2 is CECC/IECQ approved and certified in accordance with IEC/EN 60950 and UL1950. Dimensions approx. 15 x 7,5 mm board space and 10,7 mm height.

FT2 / FU2 Relays

3rd generation non polarized, non latching 2 c/o telecom relay with bifurcated contacts. Nominal voltage range from 3 ... 48 V, coil power consumption 200 ... 300 mW. Most sensitive 48 V relay. Available as through hole and surface mount type. Dielectric strength fulfills the Bellcore requirements according GR 1089 (2,5 kV – 2 / 10 μ s) and FCC part 68 (1,5 kV – 10 / 160 μ s). The FT2/FU2 is CECC/IECQ approved and certified in accordance with IEC/EN 60950 and UL1950. Dimensions approx. 15 x 7,5 mm board space and 10 mm height.

FP1 Relays

3rd generation polarized 2 c/o telecom relay with bifurcated contacts, available as non latching or latching relay with 1 or 2 coils. Nominal voltage range from 3 ... 48 V, coil power consumption of 80 ... 260 mW for the high sensitive version, 140... 300 mW for the standard version, latching relays with 1 coil 100 mW. The FP1 Relay is available as through hole type and capable to switch loads up to 30 W/62,5 VA. Dielectric strength fulfills FCC part 68 (1,5 kV – 10 / 160 μ s). The FP2 is CECC/IECQ approved. Dimensions approx. 14 x 9 mm board space and 5 mm height.

MT2 / MT4

2nd generation non polarized, non latching 2 c/o and 4 c/o telecom and signal relay with bifurcated contacts. Nominal voltage range from 4.5 ... 48 V, coil power consumption 150/200/300/400 and 550 mW, and 300 mW (MT4). Dielectric strength fulfills the requirements according FCC part 68 (1,5 kV – 10 / 160 μ s) for both and the Bellcore requirements according GR 1089 (2,5 kV – 2 / 10 μ s) the MT4 only. Dimensions MT2 approx. 20 x 10 mm board space and 11 mm height, MT4 approx. 20 x 15 mm board space and 11 mm height.

D2n Relays

2nd generation non polarized 2 c/o relay for telecom and various other applications. Nominal voltage range from 3 ... 48 V, coil power consumption from 150 ... 500 mW. The D2n relay is capable to switch currents up to 3 A. Dielectric strength fulfills the requirements according FCC part 68 (1,5 kV – 10 / 160 μ s). Dimensions approx. 20 x 10 mm board space and 11,5 mm height.

P1 Relays

Extremely sensitive, polarized 1 c/o relay with bifurcated contacts for a wide range of applications, available as non latching or latching relay with 1 or 2 coils. Nominal voltage range from 3 ... 24 V, coil power consumption 65 mW, latching relays with 1 coil 30 mW. The P1 relay is available as through hole or surface mount type and capable to switch currents up to 1 A. Dielectric strength fulfills the requirements according FCC part 68 (1,5 kV – 10 / 160 μ s). Dimensions approx. 13 x 7,6 mm board space and 7 mm height for THT or 8 mm height for SMT version.

W11 Relays

Low cost, non polarized 1 c/o relay for various applications. Nominal voltage range from 3 ... 24 V, coil power consumption 450 mW, sensitive versions 200 mW. The W11 relay is capable to switch currents up to 3 A. Dielectric strength 1000 Vrms. Dimensions approx. 15,6 x 10,6 mm board space and 11,5 mm height.

Reed Relays

High sensitive, non polarized relay for telecom and various other applications, available with 1 n/o, 2 n/o or 1 c/o contacts. Nominal voltage range from 5 ... 24 V, coil power consumption 50...280 mW for 1 n/o and 125 ... 280 mW for 2 n/o or 1 c/o versions. Reedrelays are available in DIP or SIL housing and capable to switch currents up to 0,5 A. Integrated diode and/or electrostatic shield optional. Dielectric strength 1500 Vdc. Dimensions approx. 19,3 x 7 mm board space and 5 ... 7,5 mm height for DIP or 19,8 x 5 mm board space and 7,8 mm height for SIL version.

Cradle Relays

Extremely reliable and mature relay family of 1st generation for various signal switching applications. Available as non polarized, polarized / latching and relay with AC coil. The benefit is the possibility of combining various contact sets from 1 up to 6 poles, single and bifurcated contacts, different contact materials with a coil voltage range from 1,5 Vdc to 220 Vac. Cradle relays are available as dust protected and hermetically sealed versions, with plug in or solder terminals and are capable to switch currents up to 5 A. Forcibly guided (linked) contact sets optional. Dielectric strength 500 Vrms. Dimensions from approx. 19 x 24 to 19x35 mm board space and 30 mm height.

Other Relays

We offer a variety of different relay families for maintenance and replacement purposes. These relays are up to 60 years old now, such as Card Relay SN (V23030 / V23031 series), Small General Purpose Relay (V23006 series), Small Polarized Relay (V23063 ... V23067 and V23163 ... V23167 series). Accessories like sockets, hold down springs, etc. optional.

HF3 Relay

High performance low cost RF relay with excellent RF characteristics. Available with an impedance of 50 and 75 Ohm. Suitable for frequencies up to 3 GHz. Actually smallest RF relay available combining small size, excellent RF performance and SMD solderability. Available as non latching or latching relay with 1 or 2 coils and a nominal coil voltage range from 3 ... 24 V, coil power consumption 140 mW, latching relays with 1 coil 70 mW. Dimensions 14,6 x 7,3 x 10 mm.



Tyco Electronics AXICOM Ltd.
Seestrasse 295 - P.O. Box 220
CH-8804 Au-Wädenswil / Switzerland
Phone +41 1 782 9111
Fax +41 1 782 9080
E-mail: axicom@tycoelectronics.com



Tyco Electronics AMP GmbH
Paulsternstrasse 26
D-13629 Berlin / Germany
Phone +49 30 386 38260
Fax +49 30 386 38569
E-mail: axicom@tycoelectronics.com



Tyco Electronics EC Trutnov s.r.o.
Komenského 821
CZ-541 01 Trutnov / Czech Republic
E-mail: axicom@tycoelectronics.com

Tyco Electronics Corporation
POB 3608,
Harrisburg, PA 17105, USA
Phone +1 800-522-6752