

**Features**

1. High current transfer ratio  
(CTR:MIN.500% at  $I_F=1mA$ ,  $V_{ce}=2V$ )
2. High isolation voltage between input and output  
(Viso:5000Vrms).
3. Compact dual-in-line package.
4. Available package : DIP/ SMD/ H. (For Package Dimension please refer to page 82 )

**Applications**

1. System appliances, measuring instruments.
2. Industrial robots.
3. Copiers, automatic vending machines, facsimiles.
4. Signal transmission between circuits of different potentials and impedances.
5. Telephone sets.
6. Copiers, tacsimiles.
7. Interface with various power supply circuits, power distribution boards.
8. Numerical control machines.

**Outside Dimension : Unit (mm)**

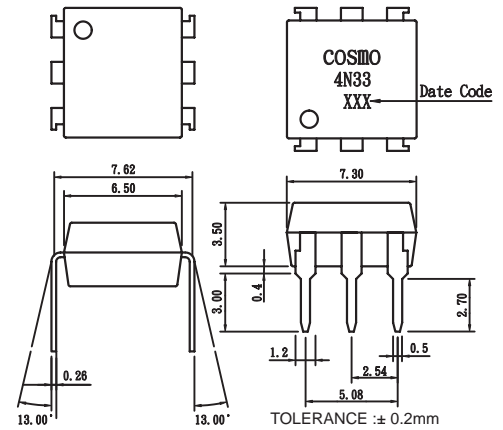

**Schematic : Top View**

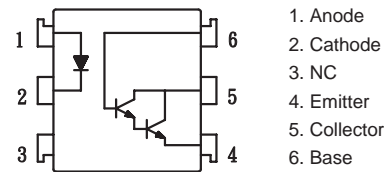

**Absolute Maximum Ratings**

( $T_a=25^{\circ}C$ )

Parameter		Symbol	Rating	Unit
Input	Forward current	$I_F$	50	mA
	Peak forward current	$I_{FM}$	1	A
	Reverse voltage	$V_R$	6	V
	Power dissipation	$P_D$	70	mW
Output	Collector-emitter voltage	$V_{CEO}$	30	V
	Collector-base voltage	$V_{CBO}$	30	V
	Emitter-base voltage	$V_{EBO}$	6	V
	Collector current	$I_c$	150	mA
	Collector power dissipation	$P_C$	200	mW
Total power dissipation		$P_{tot}$	200	mW
Isolation voltage 1 minute		Viso	5000	Vrms
Operating temperature		$T_{opr}$	-30 to +100	$^{\circ}C$
Storage temperature		$T_{stg}$	-55 to +125	$^{\circ}C$
Soldering temperature 10 second		$T_{sol}$	260	$^{\circ}C$

**Electro-optical Characteristics**

( $T_a=25^{\circ}C$ )

Parameter		Symbol	Conditions	MIN.	TYP.	MAX.	Unit
Input	Forward voltage	$V_F$	$I_F=10mA$	—	1.2	1.4	V
	Peak forward voltage	$V_{FM}$	$I_{FM}=0.5A$	—	—	3.5	V
	Reverse current	$I_R$	$V_R=4V$	—	—	10	$\mu A$
	Terminal capacitance	$C_t$	$V=0, f=1kHz$	—	30	—	pF
Output	Collector dark current	$I_{CEO}$	$V_{CE}=10V, I_F=0$	—	—	0.1	$\mu A$
Transfer characteristics	Current transfer ratio	CTR	$I_F=1mA, V_{CE}=2V$	500	—	—	%
	Collector-emitter saturation voltage	$V_{CE(sat)}$	$I_F=8mA, I_c=2mA$	—	—	1.0	V
	Isolation resistance	Riso	DC500V	$5 \times 10^{10}$	—	—	ohm
	Floating capacitance	$C_f$	$V=0, f=1MHz$	—	0.6	1.0	pF
	Cut-off frequency	$f_c$	$V_{CC}=5V, I_c=2mA, R_L=100ohm$	—	7	—	kHz
	Response time (Rise)	$t_r$	$V_{CE}=10V, I_c=50mA, R_L=100ohm$	—	5	40	$\mu s$
Response time (Fall)	$t_f$	—		60	100	$\mu s$	

**Fig.1** Forward Current vs. Ambient Temperature

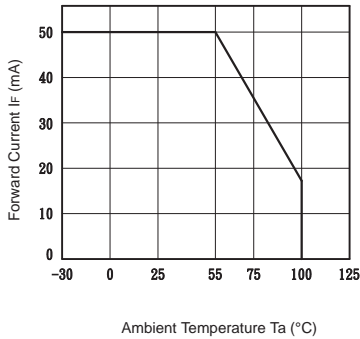

**Fig.2** Collector Power Dissipation vs. Ambient Temperature

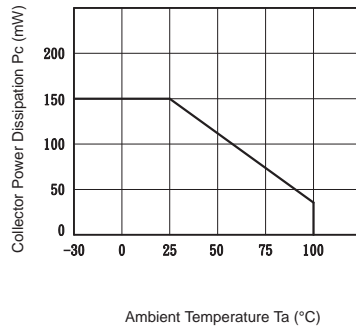

**Fig.3** Peak Forward Current vs. Duty Ratio

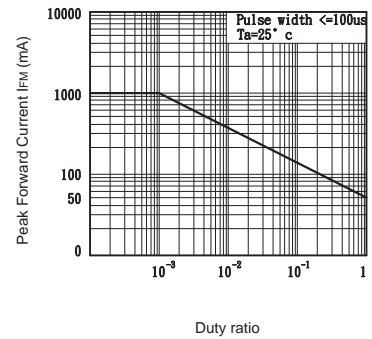

**Fig.4** Forward Current vs. Forward Voltage

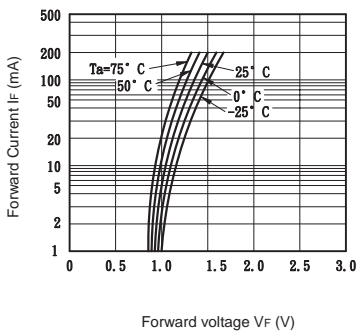

**Fig.5** Current Transfer Ratio vs. Forward Current

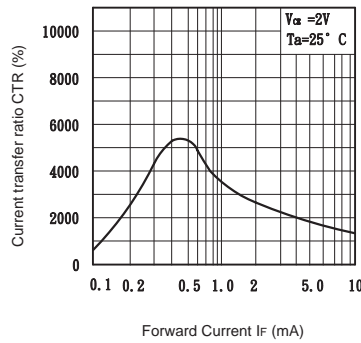

**Fig.6** Collector Current vs. Collector-emitter Voltage

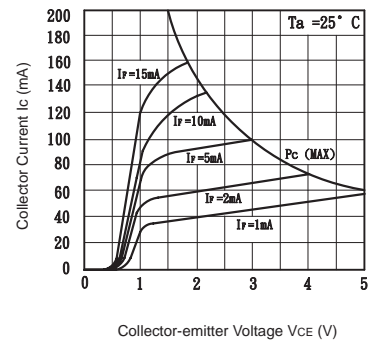

**Fig.7** Relative Current Transfer Ratio vs. Ambient Temperature

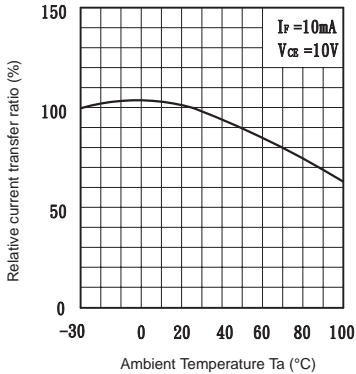

**Fig.8** Collector-emitter Saturation Voltage vs. Ambient Temperature

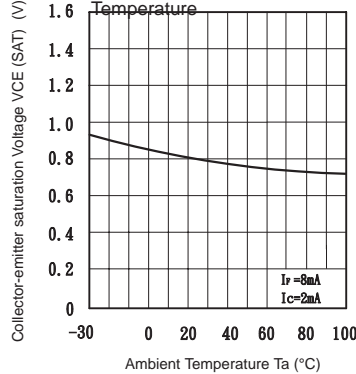

**Fig.9** Collector Dark Current vs. Ambient Temperature

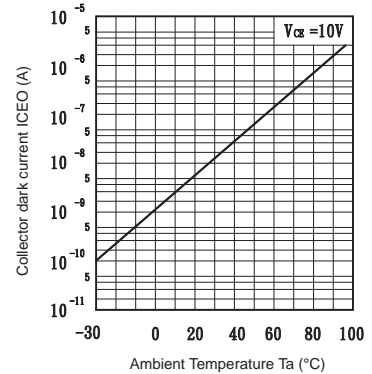

**Fig.10** Response Time vs. Load Resistance

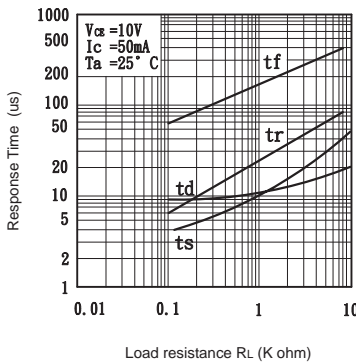

**Fig.11** Collector-emitter Saturation Voltage vs. Forward current

