

NAIS

15A (1C), 10 A (2C) SPACE SAVING POWER RELAY

HL RELAYS

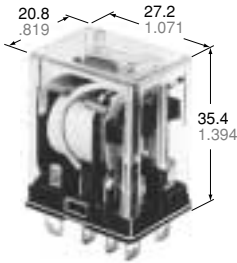

mm inch

FEATURES

- **High switching capacity in a compact size**
1 Form C (15 A 125 V AC), 2 Form C (10 A 250 V AC)
- **Rugged construction for tough applications**
- **Long life**
Mechanical: Min. 10⁸ operations (DC),
Min. 5 × 10⁷ operations (AC)
Electrical: Min. 5 × 10⁵ operations

SPECIFICATIONS

Contacts

| Arrangement | | 1 Form C | 2 Form C |
|--|----------------------------|--|--------------------------|
| Initial contact resistance, max. (By voltage drop 6 V DC 1 A) | | 50 mΩ | |
| Contact material | | Silver alloy | |
| Rating (resistive) | Nominal switching capacity | 15 A 125 V AC, 10 A 250 V AC | 10 A 250 V AC |
| | Max. switching power | AC: 2,500 VA DC: 90 W | AC: 2,500 VA DC: 90 W |
| | Max. switching voltage | 250 V AC 30 V DC | 250 V AC 30 V DC |
| | Max. switching current | 15 A | 10 A |
| Expected life | Mechanical (at 180 cpm) | 5×10 ⁷ (AC), 10 ⁶ (DC) | |
| | Electrical (resistive) | 15 A 125 V AC | 5×10 ⁵ |
| | | 10 A 250 V AC | 5×10 ⁵ |
| | 3 A 30 V DC | 5×10 ⁵ | 5×10 ⁵ |

Remarks

- * Specifications will vary with foreign standards certification ratings.
- *1 Measurement at same location as "Initial breakdown voltage" section
- *2 Detection current: 10 mA
- *3 Excluding contact bounce time
- *4 Half-wave pulse of sine wave: 11ms; detection time: 10μs
- *5 Half-wave pulse of sine wave: 6ms
- *6 Detection time: 10μs
- *7 Refer to 6. Conditions for operation, transport and storage mentioned in AMBIENT ENVIRONMENT.

Characteristics (at 25°C 77°F, 50% Relative humidity)

| | | |
|--|---------------------------|--|
| Max. operating speed | | 20 cpm |
| Initial insulation resistance*1 | | Min. 100 MΩ (at 500 V DC) |
| Initial breakdown voltage*2 | Between contact sets | 1,500 Vrms for 1 min. |
| | Between open contacts | 1,000 Vrms for 1 min. |
| | Between contacts and coil | 2,000 Vrms for 1 min. |
| Operate time (at nominal voltage) | | Max. 25 ms (DC type) Max. 25 ms (AC type) |
| Release time*3 (without diode) (at nominal voltage) | | Max. 25 ms (DC type) Max. 25 ms (AC type) |
| Temperature rise, max. (at nominal voltage) | | Max. 80°C |
| Shock resistance | Functional*4 | Min. 196 m/s ² {20 G} |
| | Destructive*5 | Min. 980 m/s ² {100 G} |
| Vibration resistance | Functional*6 | 10 to 55 Hz at double amplitude of 1 mm |
| | Destructive | 10 to 55 Hz at double amplitude of 2 mm |
| Conditions for operation, transport and storage*7 (Not freezing and condensing at low temperature) | Ambient temperature | -50°C to +70°C -58°F to +158°F |
| | Humidity | 5 to 85% R.H. |
| Unit weight | | Approx. 35 g 1.25 oz |

TYPICAL APPLICATIONS

Power station control equipment, refrigerators, building control equipment, office machines, and medical equipment.

ORDERING INFORMATION

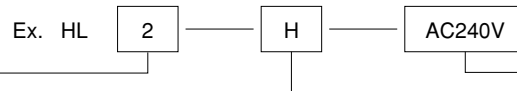

| Contact arrangement | Terminal arrangement | Coil voltage |
|----------------------------|---|---|
| 1: 1 Form C 2: 2 Form C | H: Plug-in HP: PC board HTM: Top mounting L: Light emitting diode wired, plug-in PL: Light emitting diode wired, PC board | AC 6, 12, 24, 48, 120, 240 V DC 6, 12, 24, 48, 110 V |

Note: Standard packing Carton: 20 pcs., Case: 200 pcs.
UL/CSA approved type is standard.

COIL DATA (at 20°C 68°F)

DC coils

| Coil voltage, V DC | Pick-up voltage, V DC (max.) | Drop-out voltage, V DC (min.) | Max. allowable voltage, V DC | Coil resistance, Ω (±10%) | Nominal coil current, mA | Operating power, W | |
|--------------------|------------------------------|-------------------------------|------------------------------|---------------------------|--------------------------|--------------------|---------|
| | | | | | | Nominal | Minimum |
| 6 | 4.8 | 0.6 | 6.6 | 40 | 150 | 0.90 | 0.58 |
| 12 | 9.6 | 1.2 | 13.2 | 160 | 75 | | |
| 24 | 19.2 | 2.4 | 26.4 | 650 | 37 | | |
| 48 | 38.4 | 4.8 | 52.8 | 2,600 | 18.5 | | |
| 110 | 88.0 | 11.0 | 121.0 | 10,000 | 10 | 1.0 | 0.64 |

AC coils at 60 Hz

| Coil voltage, V DC | Pick-up voltage, V AC (max.) | Drop-out voltage, V AC (min.) | Max. allowable voltage, V AC | Nominal coil current, mA | Operating power, VA | |
|--------------------|------------------------------|-------------------------------|------------------------------|--------------------------|---------------------|---------|
| | | | | | Nominal | Minimum |
| 6 | 4.8 | 1.8 | 6.6 | 200 | 1.20 | 0.77 |
| 12 | 9.6 | 3.6 | 13.2 | 100 | | |
| 24 | 19.2 | 7.2 | 26.4 | 50 | | |
| 48 | 38.4 | 14.4 | 52.8 | 25 | | |
| 110/120 | 88 | 36 | 132 | 10.9/11.9 | | |
| 220/240 | 176 | 72 | 264 | 6.0/6.5 | | |

Notes:

1. The range of coil current is ±15% for AC (60 Hz), ±10% for DC, at 20°C.
2. The relay may be used in the range of 80% to 110% of the nominal coil voltage. However, it is recommended that the relay be used at 85% to 110% nominal voltage to take temporary voltage variations into consideration.
3. Each coil resistance of DC types is the measured value at a coil temperature of 20°C. Please allow a compensation of ±0.4% resistance for each coil temperature change of ±1°C.

4. All AC 240 V types are rated for double coil voltages, both AC 220 V and AC 240 V.
5. For use with 220 or 240 V DC, connect a resistor, as suggested below, in series with the 110 V DC relay.

| Voltage | 1 Form C, 2 Form C |
|----------|--------------------|
| 220 V DC | 11 kW (5 W) |
| 240 V DC | 13 kW (5 W) |

DIMENSIONS

mm inch

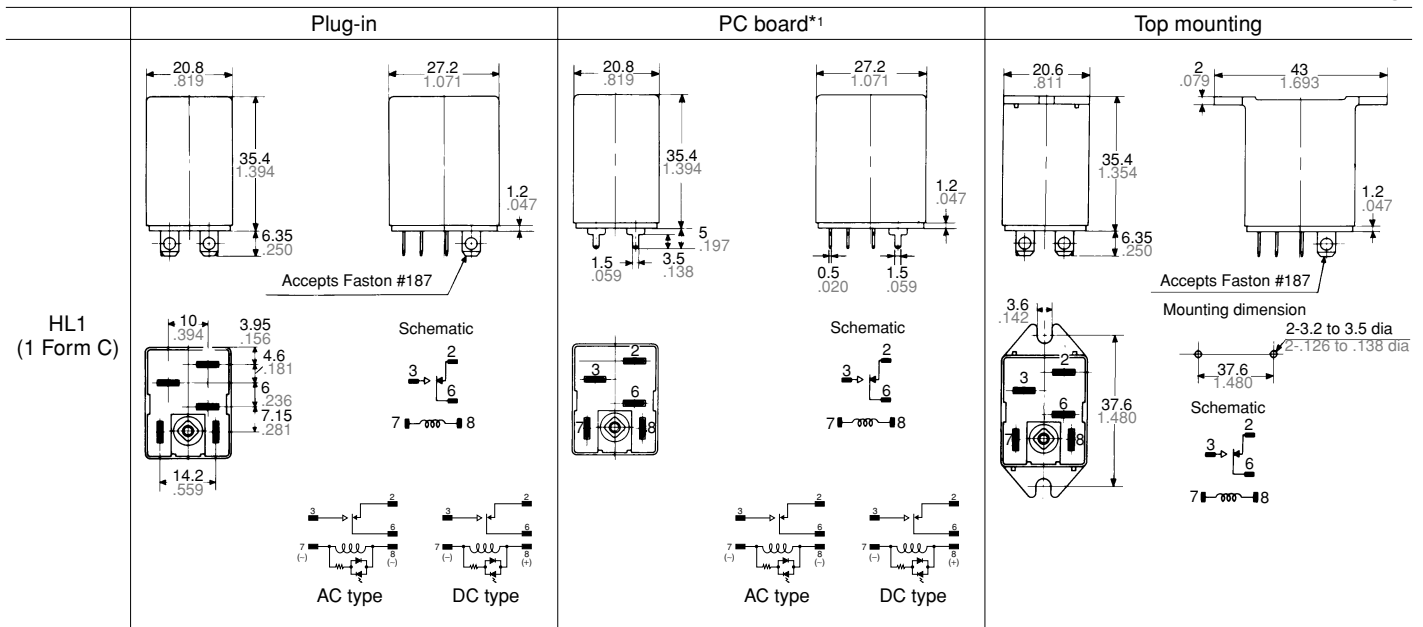

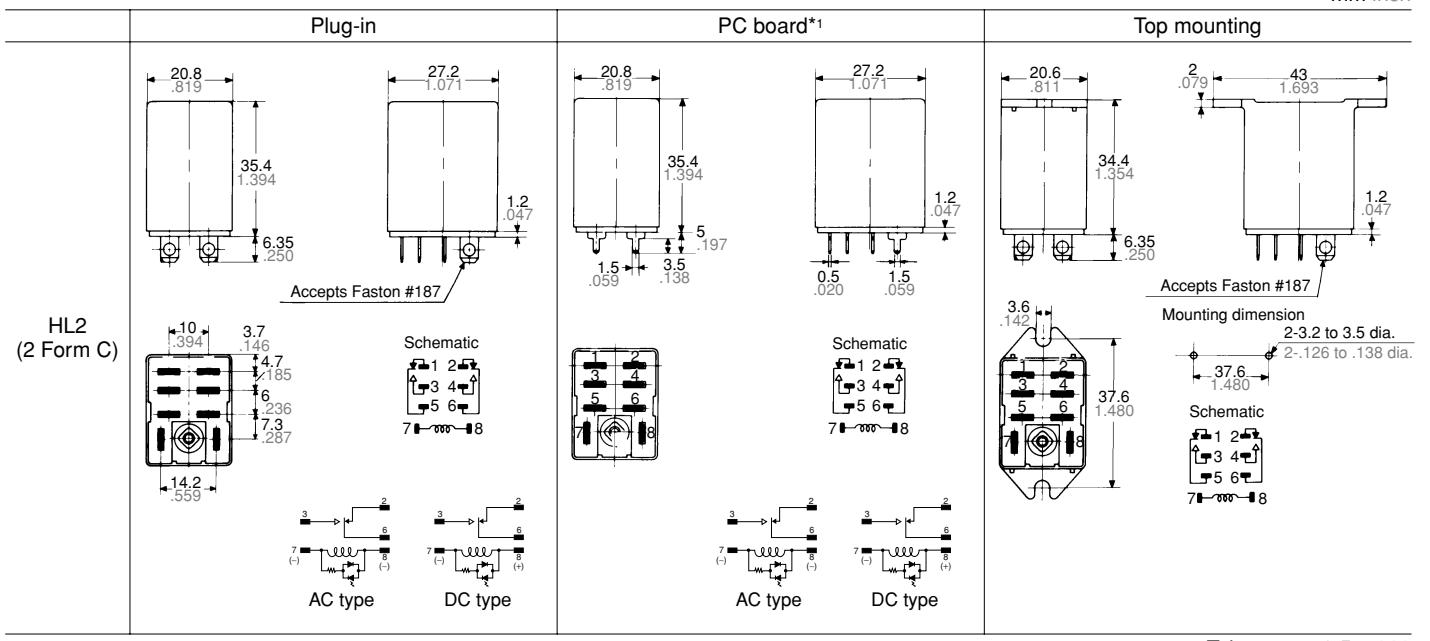

Tolerance: $\pm 0.5 \pm 0.20$

*1 PC board pattern

Copper-side view

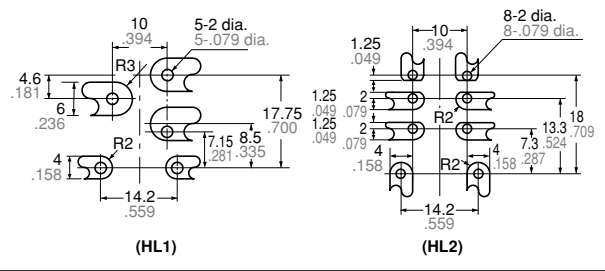
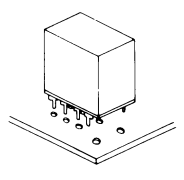

Tolerance: $\pm 0.1 \pm 0.04$

ACCESSORIES

1.Plug-in terminal Socket

HL1-SS-K (with hold-down clip)

HL2-SS-K (with hold-down clip)

Plug-in terminal socket mount
Simply insert socket into panel hole and push down as indicated to lock socket in place.

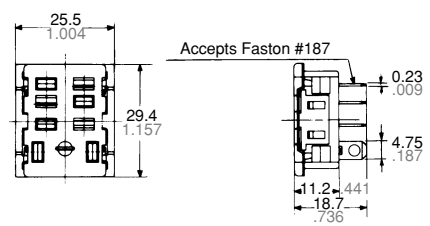
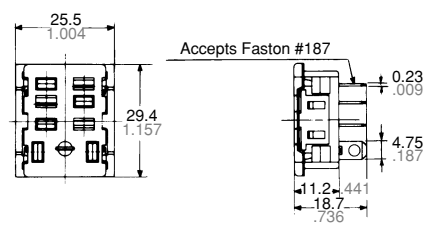
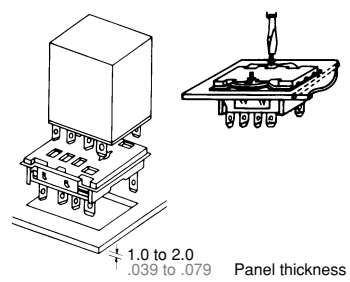

1.0 to 2.0 (.039 to .079) Panel thickness

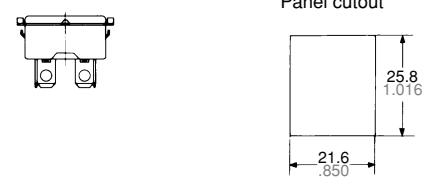
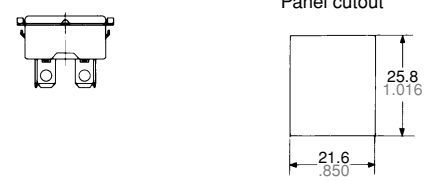

Panel cutout for tandem mounting

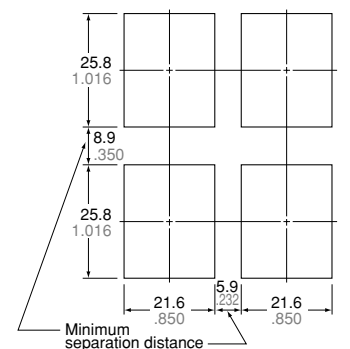

Tolerance: $\pm 0.1 \pm 0.04$

2. PC board terminal socket

HL1-PS-K

HL2-PS-K

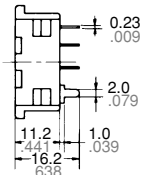
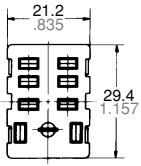

PC board pattern

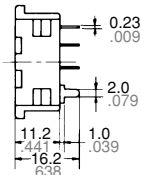
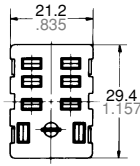
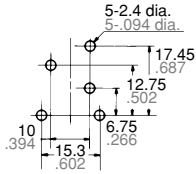

PC board pattern

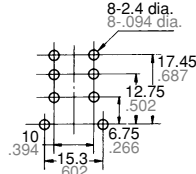

Layout for tandem mounting
(2 Form C)

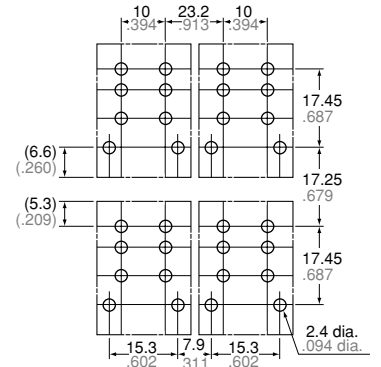

Tolerance: ±0.1 ±0.04

3. Screw terminal socket for DIN rail assembly

HL2-SFD-K (with hold-down clip)

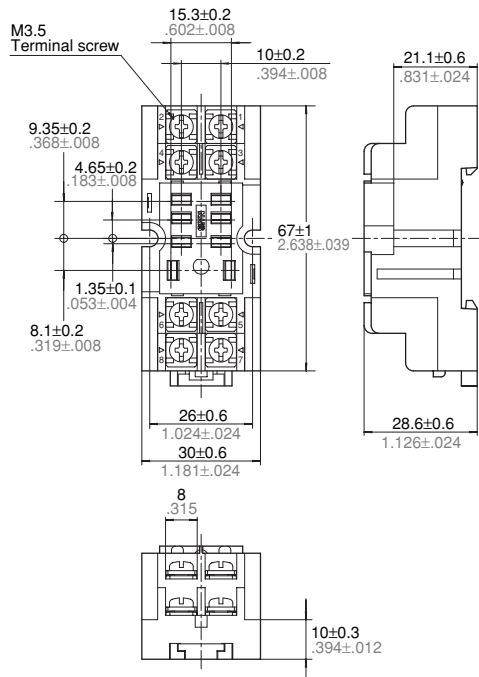
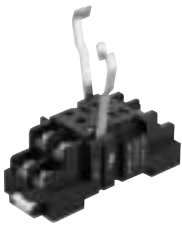

Schematic

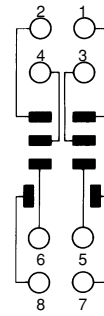

Layout for tandem mounting

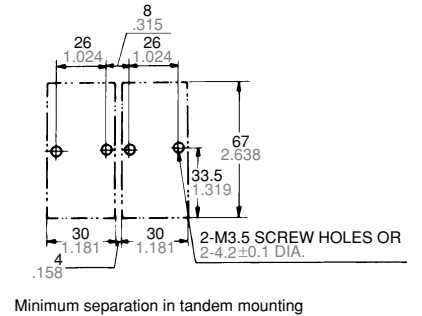

Minimum separation in tandem mounting

Tolerance: ±0.1 ±0.04

(Remark) Max. continuous current of all HL sockets is 10 A.

For Cautions for Use, see Relay Technical Information.