

NAIS

COMPACT PC BOARD POWER RELAY

JW RELAYS

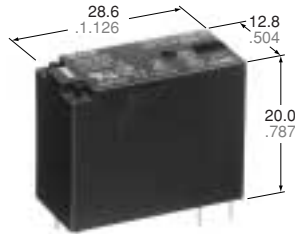

mm inch

FEATURES

- Miniature package with universal terminal footprint
- High dielectric withstanding for transient protection: 10,000 V surge in μs between coil and contact
- Sealed construction
- Class B coil insulation types available
- TV rated (TV-5) types available (only for 1 Form A type)
- VDE, TÜV, SEMKO, SEV, FIMKO, TV-5 also approved

SPECIFICATIONS

Contact

		Standard type	High capacity type
Arrangement		1 Form A, 1 Form C, 2 Form A, 2 Form C	1 Form A, 1 Form C
Initial contact resistance, max. (By voltage drop 6 V DC 1 A)		100 m Ω	
Contact material		Silver alloy	
Rating (resistive load)	Nominal switching capacity	5 A 250 V AC, 5 A 30 V DC	10 A 250 V AC, 10 A 30 V DC
	Max. switching power	1,250 VA, 150 W	2,500 VA, 300 W
	Max. switching voltage	250 V AC, 30 V DC	
	Max. switching current	5 A	10 A
Expected life (min. ope.)	Mechanical (at 180 cpm)	5 \times 10 ⁶	
	Electrical (at 6 cpm) (Resistive load)	10 ⁵	

Coil

Nominal operating power	530 mW
-------------------------	--------

Remarks

- * Specifications will vary with foreign standards certification ratings.
- *₁ Detection current: 10mA
- *₂ Wave is standard shock voltage of $\pm 1.2 \times 50\mu\text{s}$ according to JEC-212-1981
- *₃ Excluding contact bounce time
- *₄ Half-wave pulse of sine wave: 11ms; detection time: 10 μs
- *₅ Half-wave pulse of sine wave: 6ms
- *₆ Detection time: 10 μs
- *₇ Refer to 6. Conditions for operation, transport and storage mentioned in AMBIENT ENVIRONMENT.
- *₈ When using relays in a high ambient temperature, consider the pick-up voltage rise due to the high temperature (a rise of approx. 0.4% V for each 1°C 33.8°F with 20°C 68°F as a reference) and use a coil impressed voltage that is within the maximum allowable voltage range.

Characteristics

		Standard type	High capacity type
Max. operating speed (at rated load)		6 cpm	
Initial insulation resistance		Min. 1,000 M Ω at 500 V DC	
Initial breakdown voltage* ₁	Between open contacts	1,000 Vrms for 1 min.	
	Between contacts and coil	5,000 Vrms for 1 min.	
	Between contact sets	3,000 Vrms for 1 min. (2 Form A, 2 Form C)	
Initial surge voltage between contacts and coil* ₂		Min. 10,000 V	
Operate time* ₃ (at nominal voltage)		Max. 15 ms	
Release time (without diode)* ₃ (at nominal voltage)		Max. 5 ms	
Temperature rise (at 20°C) (at nominal voltage) (with nominal coil voltage and at nominal switching capacity)		1a: max. 39°C 1c, 2a, 2c: max. 55°C (resistance method)	1a: max. 45°C 1c: max. 55°C (resistance method)
Shock resistance	Functional* ₄	Min. 98 m/s ² {10 G}	
	Destructive* ₅	Min. 980 m/s ² {100 G}	
Vibration resistance	Functional* ₆	Approx. 98 m/s ² {10 G}, 10 to 55 Hz at double amplitude of 1.6 mm	
	Destructive	Approx. 117.6 m/s ² {12 G}, 10 to 55 Hz at double amplitude of 2.0 mm	
Conditions for operation, transport and storage* ₇ (Not freezing and condensing at low temperature)	Ambient temp.* ₈	-40°C to +85°C -40°F to +185°F	
	Humidity	5 to 85% R.H.	
Unit weight		Approx. 13 g .46 oz	

TYPICAL APPLICATIONS

1. Home appliances
TV sets, VCR, Microwave ovens
2. Office machines
Photocopiers, Vending machines
3. Industrial equipment
NC machines, Robots, Temperature controllers

ORDERING INFORMATION

Ex. JW 1 F S N B DC5V

Contact arrangement	Contact capacity	Protective construction	Pick-up voltage	Coil insulation class	Coil voltage
1: 1 Form C 1a: 1 Form A 2: 2 Form C 2a: 2 Form A	Nil: Standard (5 A) F: High capacity (10 A)*	S: Sealed type	N: 70% of nominal voltage	Nil: Class E insulation B: Class B insulation	DC 5, 6, 9, 12, 18, 24, 48 V

*Only for 1 Form A and 1 Form C type

UL/CSA, VDE, SEMKO, FIMKO, SEV approved type is standard.

Notes: 1. When ordering TV rated (TV-5) types, add suffix-TV (available only for 1 Form A type).

2. Standard packing: Carton: 100 pcs. Case: 500 pcs.

TYPES

Standard (5A) types

Contact arrangement	Coil voltage, V DC	Part No.	Contact arrangement	Coil voltage, V DC	Part No.
1 Form A	5	JW1aSN-DC5V	2 Form A	5	JW2aSN-DC5V
	6	JW1aSN-DC6V		6	JW2aSN-DC6V
	9	JW1aSN-DC9V		9	JW2aSN-DC9V
	12	JW1aSN-DC12V		12	JW2aSN-DC12V
	18	JW1aSN-DC18V		18	JW2aSN-DC18V
	24	JW1aSN-DC24V		24	JW2aSN-DC24V
	48	JW1aSN-DC48V		48	JW2aSN-DC48V
1 Form C	5	JW1SN-DC5V	2 Form C	5	JW2SN-DC5V
	6	JW1SN-DC6V		6	JW2SN-DC6V
	9	JW1SN-DC9V		9	JW2SN-DC9V
	12	JW1SN-DC12V		12	JW2SN-DC12V
	18	JW1SN-DC18V		18	JW2SN-DC18V
	24	JW1SN-DC24V		24	JW2SN-DC24V
	48	JW1SN-DC48V		48	JW2SN-DC48V

High capacity (10 A) types

Contact arrangement	Coil voltage, V DC	Part No.	Contact arrangement	Coil voltage, V DC	Part No.
1 Form A	5	JW1aFSN-DC5V	1 Form C	5	JW1FSN-DC5V
	6	JW1aFSN-DC6V		6	JW1FSN-DC6V
	9	JW1aFSN-DC9V		9	JW1FSN-DC9V
	12	JW1aFSN-DC12V		12	JW1FSN-DC12V
	18	JW1aFSN-DC18V		18	JW1FSN-DC18V
	24	JW1aFSN-DC24V		24	JW1FSN-DC24V
	48	JW1aFSN-DC48V		48	JW1FSN-DC48V

COIL DATA (at 20°C 68°F)

Nominal voltage, V DC	Pick-up voltage, V DC (max.) (Initial)	Drop-out voltage, V DC (min.) (Initial)	Nominal operating current, mA (±10%)	Coil resistance, Ω (±10%)	Nominal operating power, mW	Max. allowable voltage
5	3.5	0.5	106	47	530	130% V of Nominal Voltage (at 60°C 140°F) 120% V of Nominal Voltage (at 85°C 185°F)
6	4.2	0.6	88	68		
9	6.3	0.9	58	155		
12	8.4	1.2	44	270		
18	12.6	1.8	29	611		
24	16.8	2.4	22	1,100		
48	33.6	4.8	11	4,400		

1 Form A

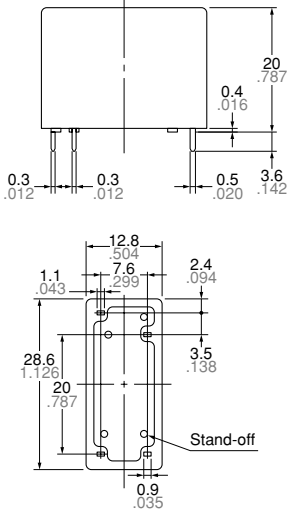

PC board pattern
(Copper-side view)

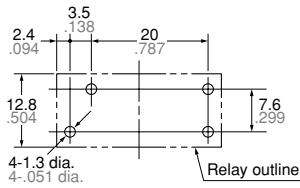

Tolerance: $\pm 0.1 \pm 0.004$

Wiring diagram (Bottom view)

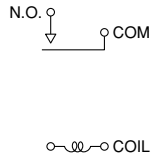

Dimension :	General tolerance
Max. 1mm .039 inch	$\pm 0.1 \pm 0.004$
1 to 3mm .039 to .118 inch	$\pm 0.2 \pm 0.008$
Min. 3mm .118 inch	$\pm 0.3 \pm 0.012$

1 Form C

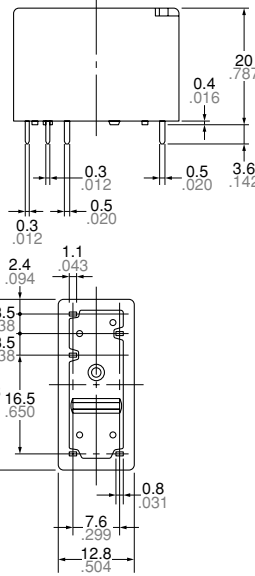

PC board pattern
(Copper-side view)

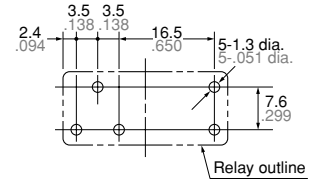

Tolerance: $\pm 0.1 \pm 0.004$

Wiring diagram (Bottom view)

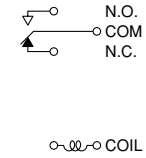

2 Form A

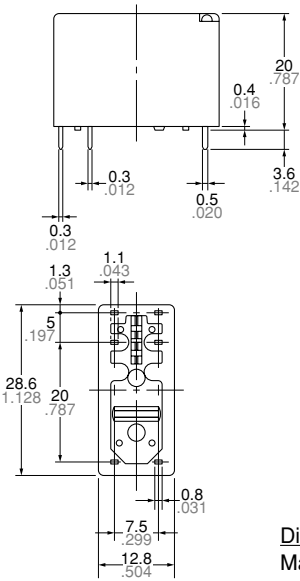

PC board pattern
(Copper-side view)

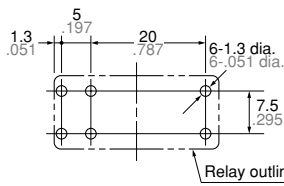

Tolerance: $\pm 0.1 \pm 0.004$

Wiring diagram (Bottom view)

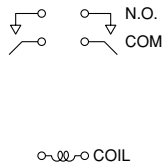

Dimension :	General tolerance
Max. 1mm .039 inch	$\pm 0.1 \pm 0.004$
1 to 3mm .039 to .118 inch	$\pm 0.2 \pm 0.008$
Min. 3mm .118 inch	$\pm 0.3 \pm 0.012$

2 Form C

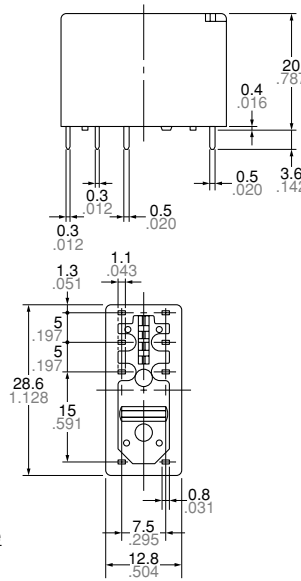

PC board pattern
(Copper-side view)

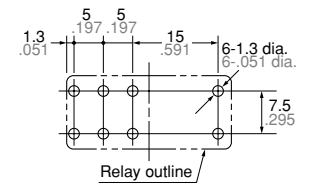

Tolerance: $\pm 0.1 \pm 0.004$

Wiring diagram (Bottom view)

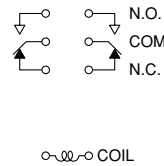

REFERENCE DATA

1-(1). Maximum operating power
1 Form A Standard (5 A) type

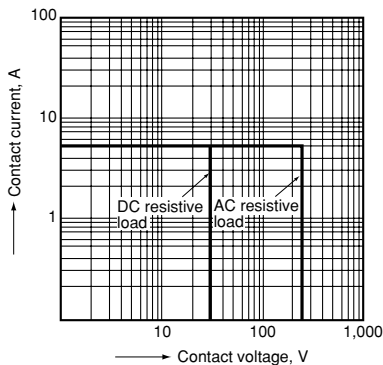

1-(2). Maximum operating power
1 Form A High Capacity (10 A) type

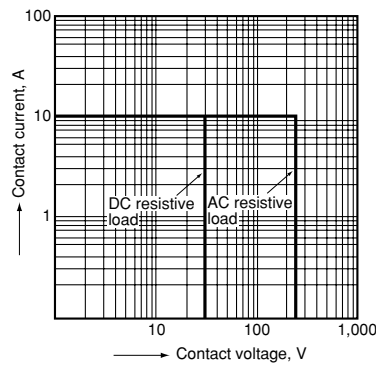

1-(3). Maximum operating power
1 Form C Standard (5 A) type

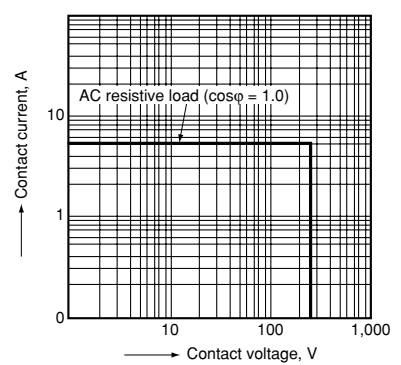

1-(4). Maximum operating power
1 Form C High Capacity (10 A) type

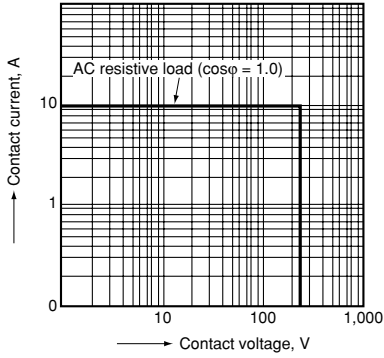

1-(5). Maximum operating power
2 Form A Standard (5 A) type

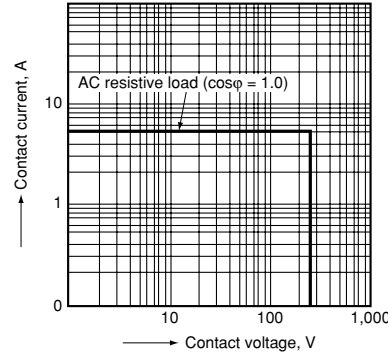

1-(6). Maximum operating power
2 Form C Standard (5 A) type

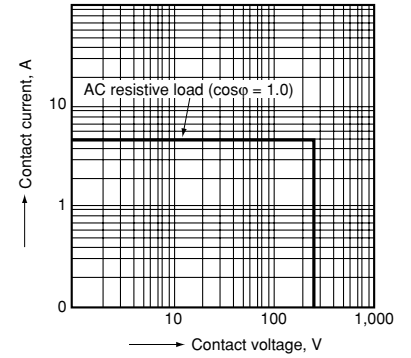

2-(1). Life curve
1 Form A Standard (5 A) type

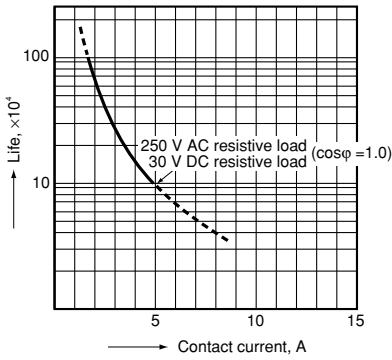

2-(2). Life curve
1 Form A High Capacity (10 A) type

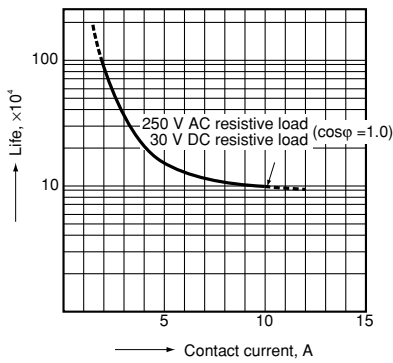

3-(1). Operate/release time
Sample: JW1aSN-DC12V, 10 pcs.
Ambient temperature: 20°C 68°F

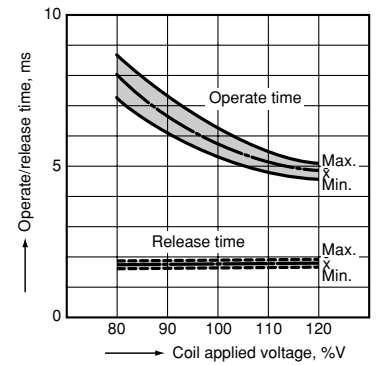

3-(2). Operate/release time
Sample: JW1aFSN-DC12V, 10 pcs.
Ambient temperature: 20°C 68°F

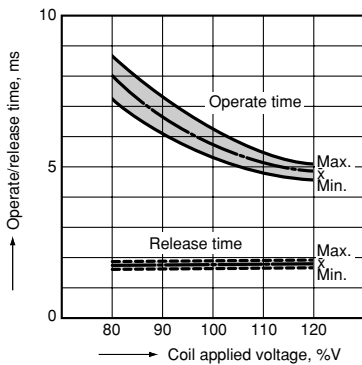

3-(3). Operate/release time
Sample: JW1SN-DC12V, 6 pcs.
Ambient temperature: 20°C 68°F

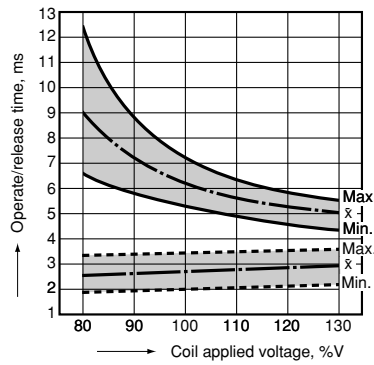

3-(4). Operate/release time
Sample: JW2aSN-DC24V, 6 pcs.
Ambient temperature: 20°C 68°F

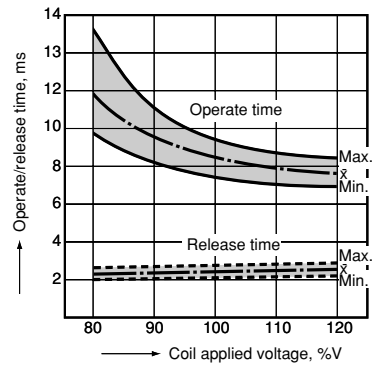

3-(5). Operate/release time
Sample: JW2SN-DC12V, 6 pcs.
Ambient temperature: 20°C 68°F

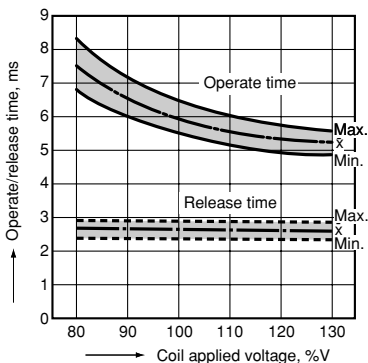

4-(1). Coil temperature rise
(Contact carrying current: 5A)
Sample JW1aFSN-DC12V, 6 pcs.
Point measured: Inside the coil

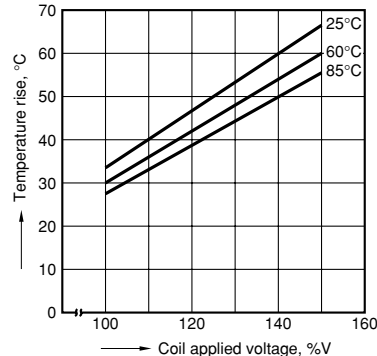

4-(2). Coil temperature rise
(Contact carrying current: 10 A)
Sample: JW1aFSN-DC12V, 6 pcs.
Point measured: Inside the coil

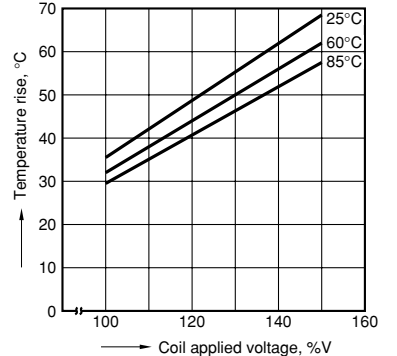

ACCESSORIES

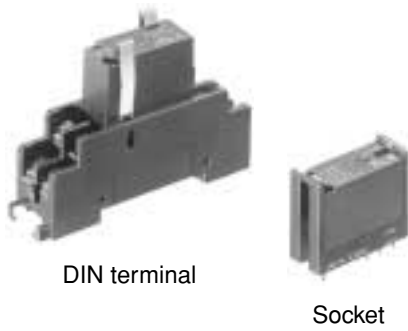

DIN terminal

Socket

FEATURES

1. Space saving design
2. Wiring can be done with ease (DIN terminal)

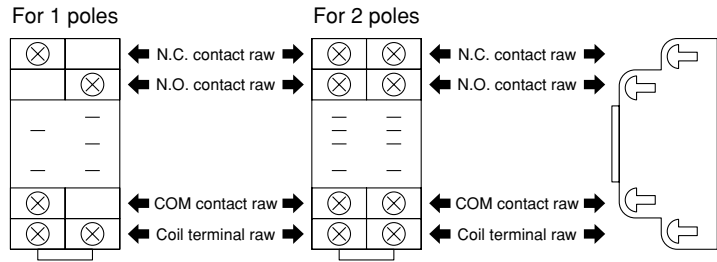

TYPES

Product name	Number of poles	Part No.	Applicable relay type				Standard packing	
			1 Form A	1 Form C	2 Form A	2 Form C	Inner carton	Outer case
JW1 DIN terminal socket (with hold-down clip)	1	JW1-SFD	•	•			10 pcs.	100 pcs.
JW2 DIN terminal socket (with hold-down clip)	2	JW2-SFD			•	•		
JW1 PC board socket	1	JW1-PS	•	•				
JW2 PC board socket	2	JW2-PS			•	•		
JW1 Plug-in socket	1	JW1-SS	•	•				
JW2 Plug-in socket	2	JW2-SS			•	•		

SPECIFICATIONS

Item	Type	PC board socket/Plug-in socket		DIN terminal socket	
		1 pole	2 poles	1 pole	2 poles
Breakdown voltage		1,500 vrms for 1 minute		1,500 Vrms for 1 minute	1,000 Vrms for 1 minute
Insulation resistance		Min. 100 MΩ		Min. 100 MΩ	

DIMENSIONS

mm inch

1. DIN terminal socket

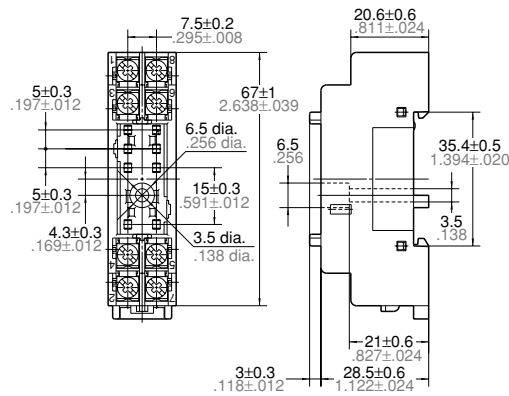

2. PC board socket

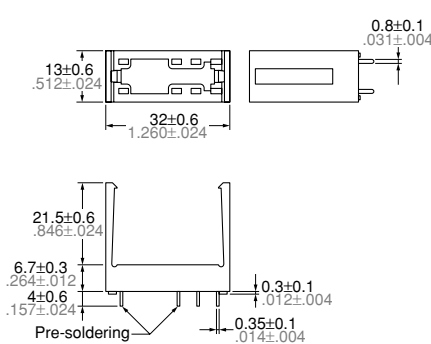

PC board pattern (Bottom view)

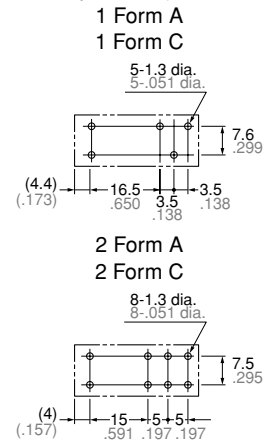

Tolerance: ±0.1 ±0.04

3. Plug-in socket

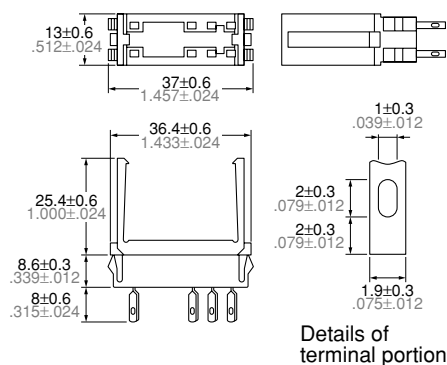

Panel cut-out
(Thickness: 1.0 to 2.0 .039 to .079)

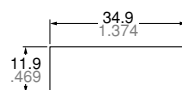

Tolerance: ±0.1 ±0.04

For Cautions for Use, see Relay Technical Information.