

NAIS

1 Form A Slim Power Relay

LD RELAYS (ALD)

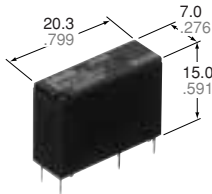

mm inch

FEATURES

1. Slim type: Width 7 mm .276 inch.

20.3(L)×7.0(W)×15.0(H) mm
.799(L)×.276(W)×.591(H) inch

2. Perfect for small load switching of home appliances

10⁵ switching operations possible with a 3A 250V AC resistive load.

3. Low operating power

Compact size, nominal operating power as low as 200mW.

4. High shock resistance

The relay withstands a functional shock resistance of 300m/s² [approx. 30 G more]

5. High insulation resistance

• Creepage distance and clearances between contact and coil: Min. 6 mm .236 inch (In compliance with IEC65)

• Surge withstand voltage between contact and coil: 10,000 V or more.

6. UL/CSA, VDE, TÜV approved.

SPECIFICATIONS

Contact

Arrangement	1 Form A		
Initial contact resistance, max. (By voltage drop 6 V DC 1 A)	Max. 100 mΩ		
Contact material	Silver alloy		
Rating (resistive load)	Nominal switching capacity	3 A 277 V AC, 3 A 30V DC	
	Max. switching power	831 V A (AC), 90W (DC)	
	Max. switching voltage	277 V AC, 30 V DC	
	Max. switching current	3 A	
Expected life (min. operations)	Mechanical (at 180 cpm)	5×10 ⁶	
	Electrical (at 20 cpm) (at rated load)	3A 125V AC, 3A 30V DC	2×10 ⁵
		3A 250V AC	10 ⁵

Coil

Nominal operating power	200 mW
-------------------------	--------

Remarks

- * Specifications will vary with foreign standards certification ratings.
- *₁ Measurement at same location as "Initial breakdown voltage" section.
- *₂ Detection current: 10mA
- *₃ Wave is standard shock voltage of ±1.2×50ms according to JEC-212-1981
- *₄ Excluding contact bounce time.
- *₅ Half-wave pulse of sine wave: 11 ms; detection time: 10 μs
- *₆ Half-wave pulse of sine wave: 6 ms
- *₇ Detection time: 10 μs
- *₈ Refer to 6. Conditions for operation, transport and storage mentioned in AMBIENT ENVIRONMENT.

Characteristics

Max. operating speed	20 cpm (at rated load)	
Initial insulation resistance* ₁	Min. 1,000 MΩ (at 500 V DC)	
Initial* ₂ breakdown voltage	Between open contacts	750 Vrms for 1 min.
	Between contact and coil	4,000 Vrms for 1 min.
Initial surge voltage between contact and coil* ₃	Min. 10,000 V	
Operate time* ₄ (at nominal voltage)	Max. 10ms (at 20°C 68°F)	
Release time (with diode)* ₄ (at nominal voltage)	Max. 10ms (at 20°C 68°F)	
Temperature rise (at 70°C 158°F)	Max. 45°C with nominal coil voltage and at 3 A contact carrying current (resistance method)	
Shock resistance	Functional* ₅	Min. 300 m/s ² {approx. 30 G}
	Destructive* ₆	Min. 1,000 m/s ² {approx. 100 G}
Vibration resistance	Functional* ₇	10 to 55Hz at double amplitude of 1.5mm
	Destructive	10 to 55Hz at double amplitude of 1.5mm
Conditions for operation, transport and storage* ₈ (Not freezing and condensing at low temperature)	Ambient temp.	-40°C to +70°C -40°F to +158°F
	Humidity	5 to 85% R.H.
Unit weight	Approx. 4 g .14 oz	

TYPICAL APPLICATIONS

- Air conditioner
- Refrigerator
- Hot water units
- Microwave ovens
- Fan heaters

ORDERING INFORMATION

Ex. A LD 1 12 W

Product name	Contact arrangement	Coil voltage (V DC)	Packing style
LD	1: 1 Form A	4H: 4.5, 09: 9, 24: 24 05: 5, 12: 12 06: 6, 18: 18	Nil: Tube packing W: Carton packing

UL/CSA, TÜV, VDE approved type is standard.

Note: Tube packing: Tube: 50pcs, Case: 1,000pcs

Carton packing: Carton: 100pcs, Case: 500pcs

LD (ALD)

TYPES AND COIL DATA (at 20°C 68°F)

Part No.	Nominal voltage, V DC	Pick-up voltage, V DC (max.) (Initial)	Drop-out voltage, V DC (min.) (Initial)	Coil resistance, Ω (±10%)	Nominal operating current, mA (±10%)	Nominal operating power, mW	Maximum allowable voltage, V DC (at 20°C 68°F)
ALD14H	4.5	3.38	0.22	101	44.6	200	5.85
ALD105	5	3.75	0.25	125	40.0	200	6.5
ALD106	6	4.5	0.3	180	33.3	200	7.8
ALD109	9	6.75	0.45	405	22.2	200	11.7
ALD112	12	9	0.6	720	16.7	200	15.6
ALD118	18	13.5	0.9	1,620	11.1	200	23.4
ALD124	24	18	1.2	2,880	8.3	200	31.2

DIMENSIONS

mm inch

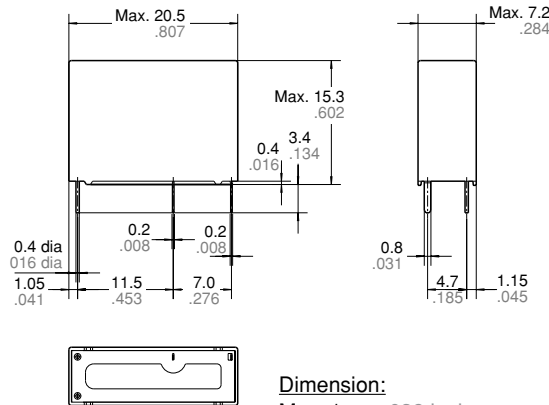

PC board pattern (Bottom view)

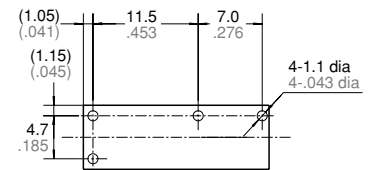

Tolerance: $\pm 0.1 \pm 0.004$

Schematic (Bottom view)

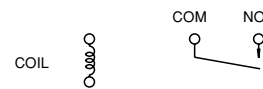

Dimension:

Max. 1mm .039 inch:

1 to 3mm .039 to .118 inch:

Min. 3mm .118 inch:

General tolerance

$\pm 0.1 \pm 0.004$

$\pm 0.2 \pm 0.008$

$\pm 0.3 \pm 0.012$

REFERENCE DATA

1. Max. switching power

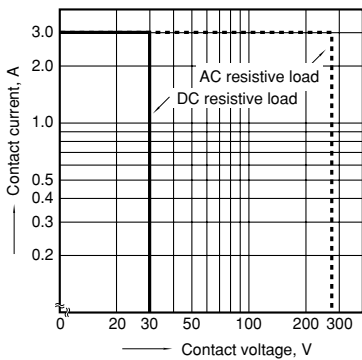

2. Life curve

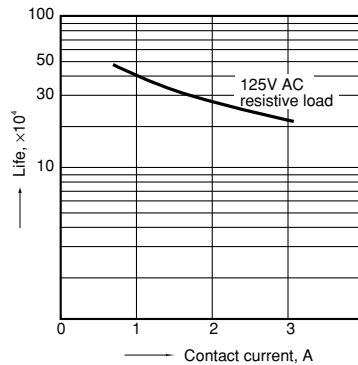

3. Coil temperature rise

Sample: ALD112, 6 pcs.
Point measured: inside the coil
Contact current: 0 A, 3 A

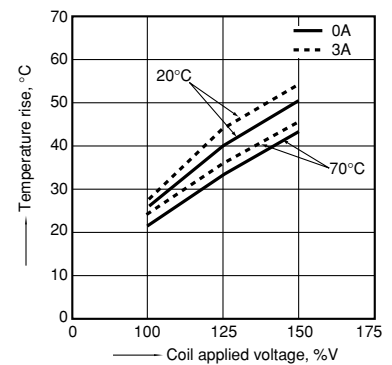

4-(1). Operate time

Sample: ALD112, 6 pcs.

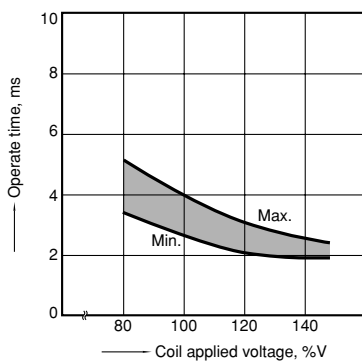

4-(2). Release time (without diode)

Sample: ALD112, 6 pcs.

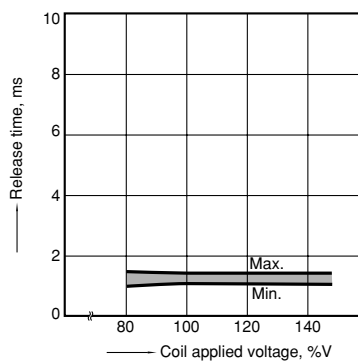

4-(3). Release time (with diode)

Sample: ALD112, 6 pcs.

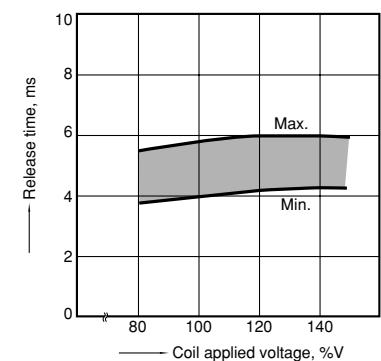

5-(1). Electrical life test (3 A 250 V AC, resistive load)

Sample: ALD112, 6 pcs.
Operating speed: 20 cpm
Ambient temperature: room temperature
circuit:

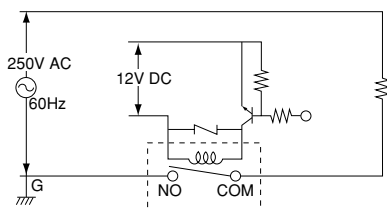

Change of pick-up and drop-out voltage

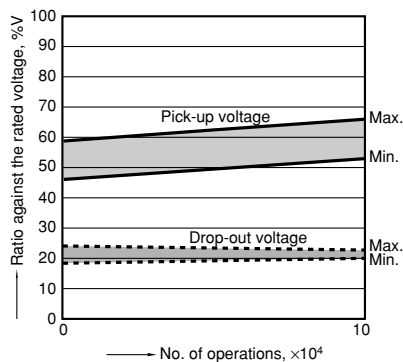

Change of contact resistance

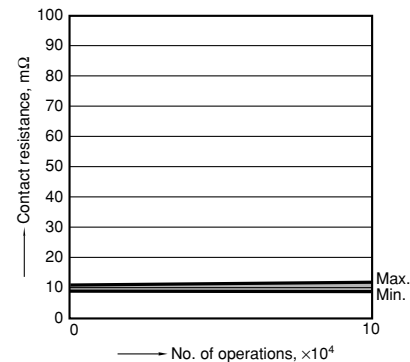

5-(2). Electrical life test (3 A 30 V DC, resistive load)

Sample: ALD112, 6 pcs.
Operating speed: 20 cpm
Ambient temperature: room temperature
circuit:

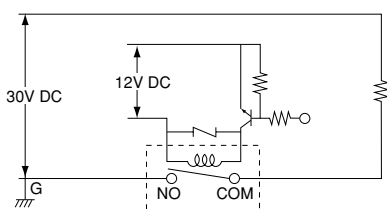

Change of pick-up and drop-out voltage

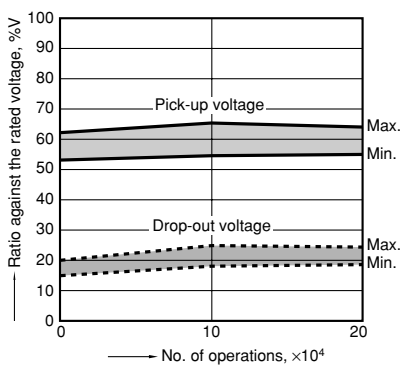

Change of contact resistance

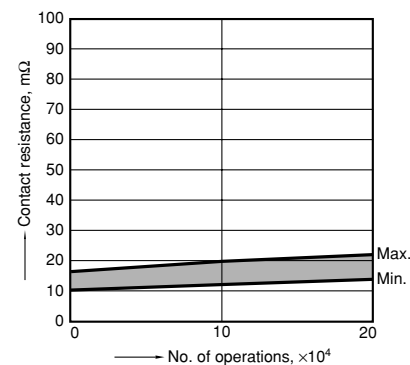

For Cautions for Use, see Relay Technical Information.