

NAIS

SLIM POWER RELAY WITH HIGH INRUSH CURRENT CAPABILITY

LK RELAYS

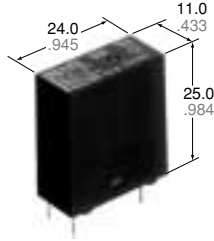

mm inch

2. High insulation resistance between contact and coil

1) Creepage distance and clearances between contact and coil: Min. 6 mm .236 inch (In compliance with IEC65)

2) Surge withstand voltage between contact and coil: 10,000 V or more

3. High noise immunity realized by the card separation structure between contact and coil

4. Popular terminal pitch in AV equipment field

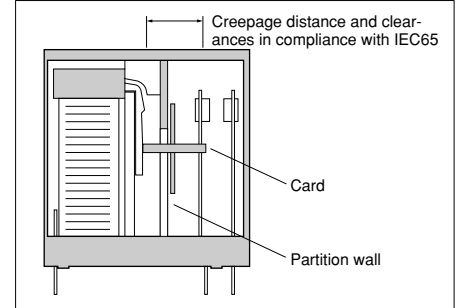

5. Space-saving slim type

Base area: Width 11 × Length 24 mm
Width .433 × Length .945 inch

6. Conforms to the various safety standards

UL, CSA, VDE, TÜV, SEMKO, SEV, BSI approved

FEATURES

1. High inrush current capability

- Operating load capability: inrush 100 A, steady 5 A
- UL/CSA, TV-5

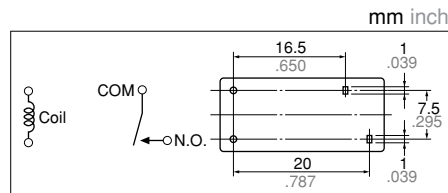

SPECIFICATIONS

Contact

Arrangement	1 Form A	
Initial contact resistance, max. (By voltage drop 6 V DC 1 A)	Max. 100 mΩ	
Contact material	Silver alloy	
Rating (resistive load)	Nominal switching capacity	5 A 277 V AC, 5 A 30 V DC
	Max. switching power	1,385 VA, 150 W
	Max. switching voltage	277 V AC, 30 V DC
	Max. switching current	5A (AC), 5 A (DC)
Expected life (min. ope.)	Mechanical (at 180 cpm)	2 × 10 ⁶
	Electrical (at 20 cpm) (at rated load)	10 ⁵

Coil

Nominal operating power	530 mW
-------------------------	--------

Remarks

- * Specifications will vary with foreign standards certification ratings.
- *¹ Measurement at same location as "Initial breakdown voltage" section.
- *² Detection current: 10mA
- *³ Wave is standard shock voltage of ±1.2 × 50μs according to JEC-212-1981
- *⁴ Excluding contact bounce time.
- *⁵ Half-wave pulse of sine wave: 11 ms; detection time: 10 μs
- *⁶ Half-wave pulse of sine wave: 6 ms
- *⁷ Detection time: 10 μs
- *⁸ Refer to 6. Conditions for operation, transport and storage mentioned in AMBIENT ENVIRONMENT.

Characteristics

Max. operating speed	20 cpm	
Initial insulation resistance* ¹	Min. 1,000 MΩ (at 500 V DC)	
Initial breakdown voltage* ²	Between open contacts	1,000 Vrms for 1 min
	Between contacts and coil	4,000 Vrms for 1 min
Initial surge voltage between contact and coil* ³	Min. 10,000 V	
Operate time* ⁴ (at nominal voltage)	Approx. 7 ms (at 20°C 68°F)	
Release time (without diode)* ⁴ (at nominal voltage)	Approx. 2 ms (at 20°C 68°F)	
Temperature rise (at 70°C)	Max. 35°C with nominal coil voltage at 5A contact carrying current (resistance method)	
Shock resistance	Functional* ⁵	Min. 200 m/s ²
	Destructive* ⁶	Min. 1,000 m/s ²
Vibration resistance	Functional* ⁷	10 to 55 Hz at double amplitude of 1.5 mm
	Destructive	10 to 55 Hz at double amplitude of 1.5 mm
Conditions for operation, transport and storage* ⁸ (Not freezing and condensing at low temperature)	Ambient temp.	-40 to +70°C -40 to +158°F
	Humidity	5 to 85%R.H.
	Air pressure	86 to 106 kPa
Unit weight	Approx. 12 g .42 oz	

TYPICAL APPLICATIONS ORDERING INFORMATION

- AV equipment: TV's, VTR's, etc.
- OA equipment
- HA equipment

Ex. LK 1a F — 24V

Contact arrangement	Protective construction	Coil voltage (DC)
1a: 1 Form A	F: Flux-resistant type	5, 6, 9, 12, 18, 24 V

UL/CSA, TÜV, SEMKO, TV-5 approved type is standard.
(Note) Standard packing Carton: 100 pcs. Case: 500 pcs.

TYPES AND COIL DATA (at 20°C 68°F)

Part No.	Nominal voltage, V DC	Pick-up voltage V DC (max.) (Initial)	Drop-out voltage V DC (min.) (Initial)	Coil resistance, Ω (±10%)	Nominal operating current, mA (±10%)	Nominal operating power, mW	Max. allowable voltage, V DC (at 20°C 68°F)
LK1aF-5V	5	3.5	0.5	47	106.4	530	6.5
LK1aF-6V	6	4.2	0.6	68	88.3	530	7.8
LK1aF-9V	9	6.3	0.9	153	58.8	530	11.7
LK1aF-12V	12	8.4	1.2	272	44.2	530	15.6
LK1aF-18V	18	12.6	1.8	611	29.5	530	23.4
LK1aF-24V	24	16.8	2.4	1,087	22.1	530	31.2

DIMENSIONS

mm inch

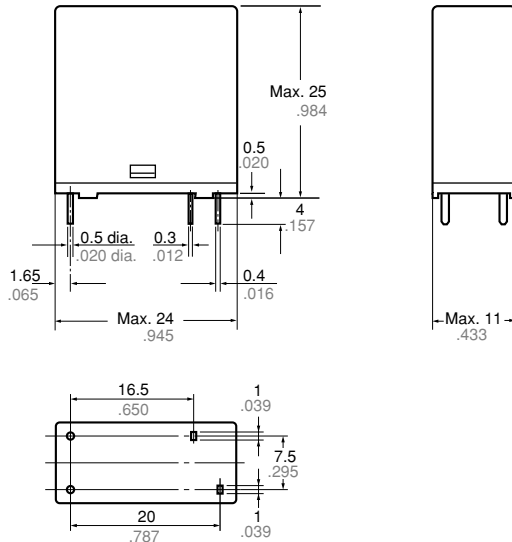

PC board pattern (Bottom view)

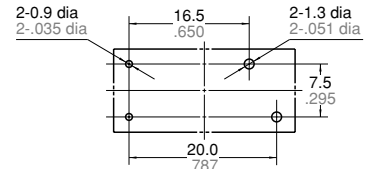

Tolerance ±0.1 ±.004

Schematic (Bottom view)



Dimension :

Max. 1mm .039 inch:

1 to 3mm .039 to .118 inch:

Min. 3mm .118 inch:

General tolerance

±0.1 ±.004

±0.2 ±.008

±0.3 ±.012

REFERENCE DATA

1. Max. switching power (AC resistive load)

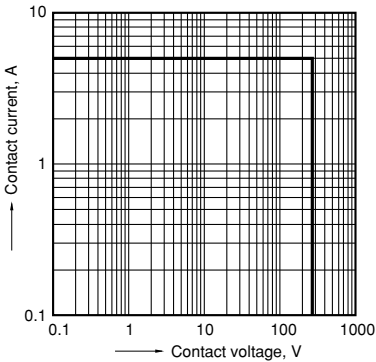

2. Coil temperature rise

Sample: LK1aF-12V, 6 pcs.
Point measured: coil inside
Contact current: 5 A

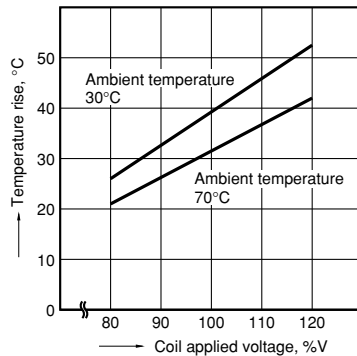

3. Ambient temperature characteristics

Contact current: 5 A

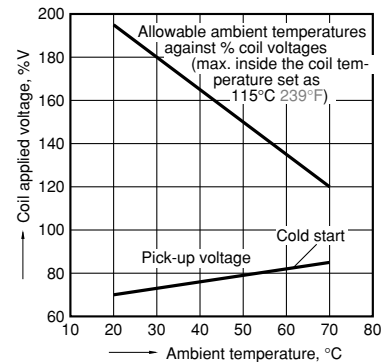

4. Life curve

Operation frequency: 20 times/min.
(ON/OFF = 1.5s: 1.5s)

Ambient temperature: room temperature

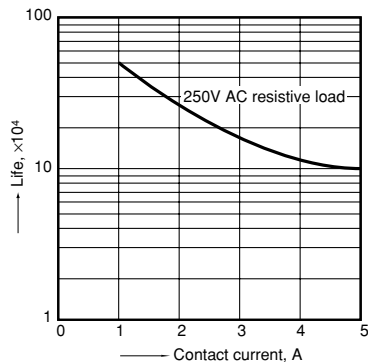

5-1. Operate & release time (without diode)

Sample: LK1aF-12V, 20 pcs.

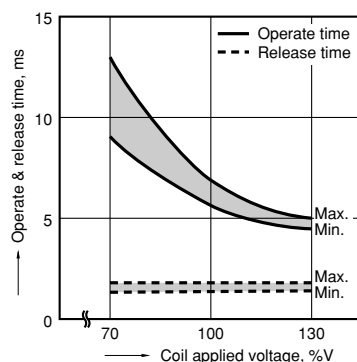

5-2. Operate & release time (with diode)

Sample: LK1aF-12V, 20 pcs.

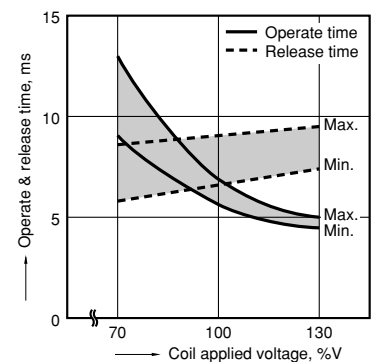

6-1. Electrical life test
 (5 A 277 V AC, resistive load)
 Sample: LK1aF-12V, 6 pcs.
 Operation frequency: 20 times/min.
 (ON/OFF = 1.5s: 1.5s)
 Ambient temperature: 26°C 79°F

Circuit:

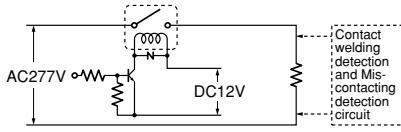

Change of pick-up and drop-out voltage

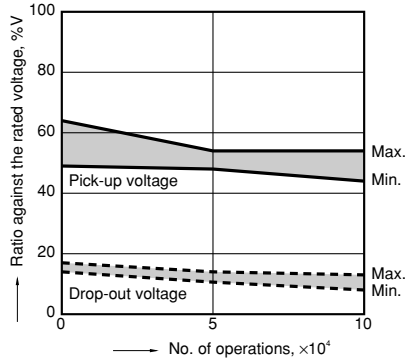

Change of contact resistance

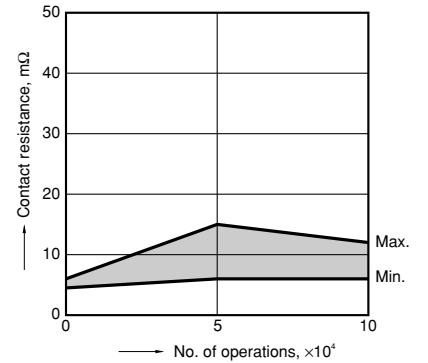

6-2. Electrical life test
 (UL lamp load test TV-5)
 Tested sample: LK1aF-12V, 6 pcs.
 • Overload test
 Load: 7.5 A 120 V AC (60 Hz),
 Inrush: 111 A
 Operation frequency: 10 times/min
 (ON: OFF = 1 s: 5 s)
 No. of operations: 50 ope.
 • Endurance test
 Load: 5A 120 V AC (60 Hz),
 Inrush: 78 A
 Operation frequency: 10 times/min
 (ON: OFF = 1 s: 5 s)
 No. of operations: 25,000 ope.

Change of pick-up and drop-out voltage

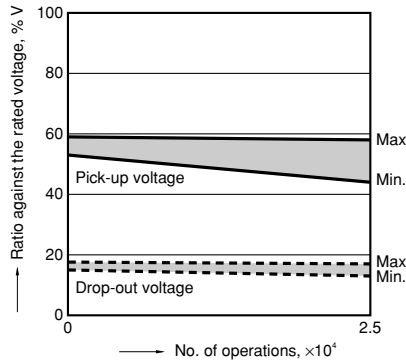

Change of contact resistance

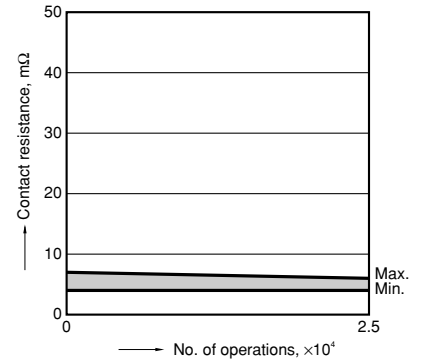

NOTES

1. Cleaning

This relay is not the sealed type, so it cannot be immersion cleaned. Be careful that flux does not overflow onto the PC board or penetrate inside the relay.

2. Soldering

We recommend the following soldering conditions.

- 1) Automatic soldering
 - * Preheating: 100°C 212°F, within 2 mins (PC board solder surface)
 - * Soldering: 260°C 500°F, within 5 s

2) Hand soldering

- * Iron tip temperature: 280 to 300°C 536 to 571°F
- * Soldering iron: 30 to 60W
- * Soldering time: Within 3 s

For Cautions for Use, see Relay Technical Information.